

# Hydraulic Crawler Crane

## SL6000S

Max. Lifting Capacity : **550 t x 8.3 m**  
Max. Crane Boom Length : **126.0 m (Long Boom)**  
Max. Luffing Jib Combination : **84.0 m + 84.0 m**

Model : SL6000S

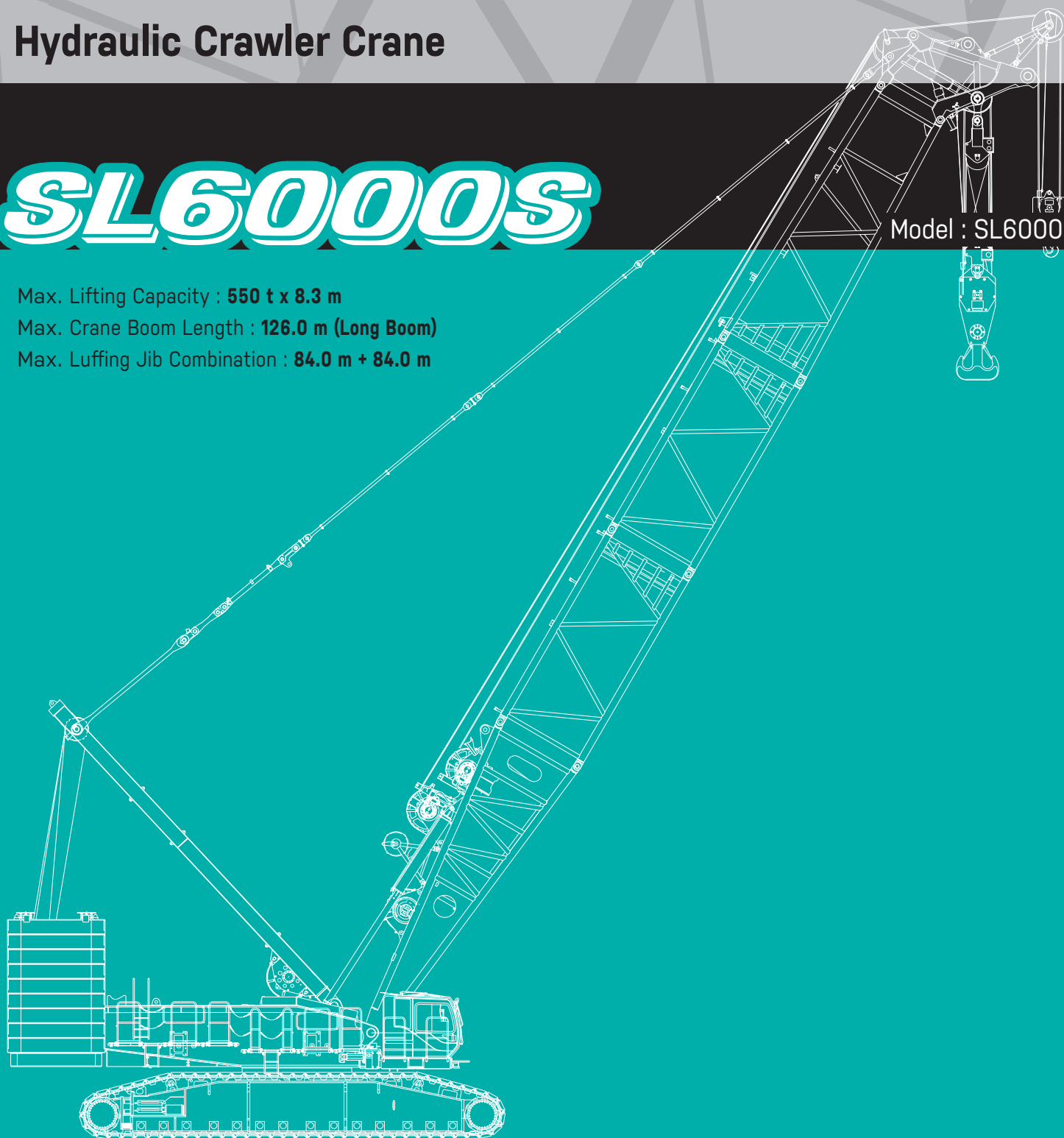

**KOBELCO**

# CONFIGURATION

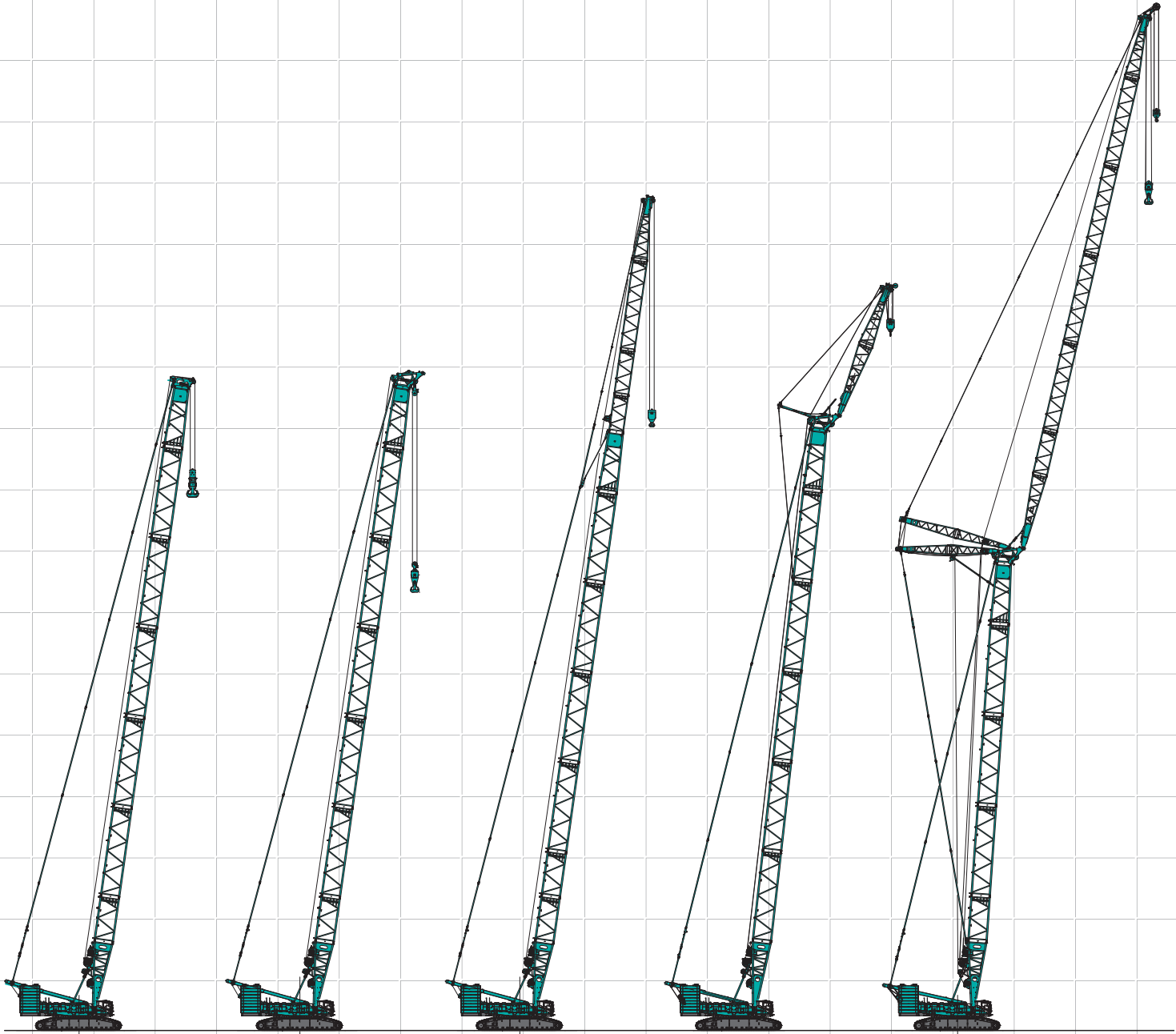





STD Heavy Duty Crane Boom

STD Luffing Boom

STD Long Boom

STD Heavy Fixed Jib (Type A)



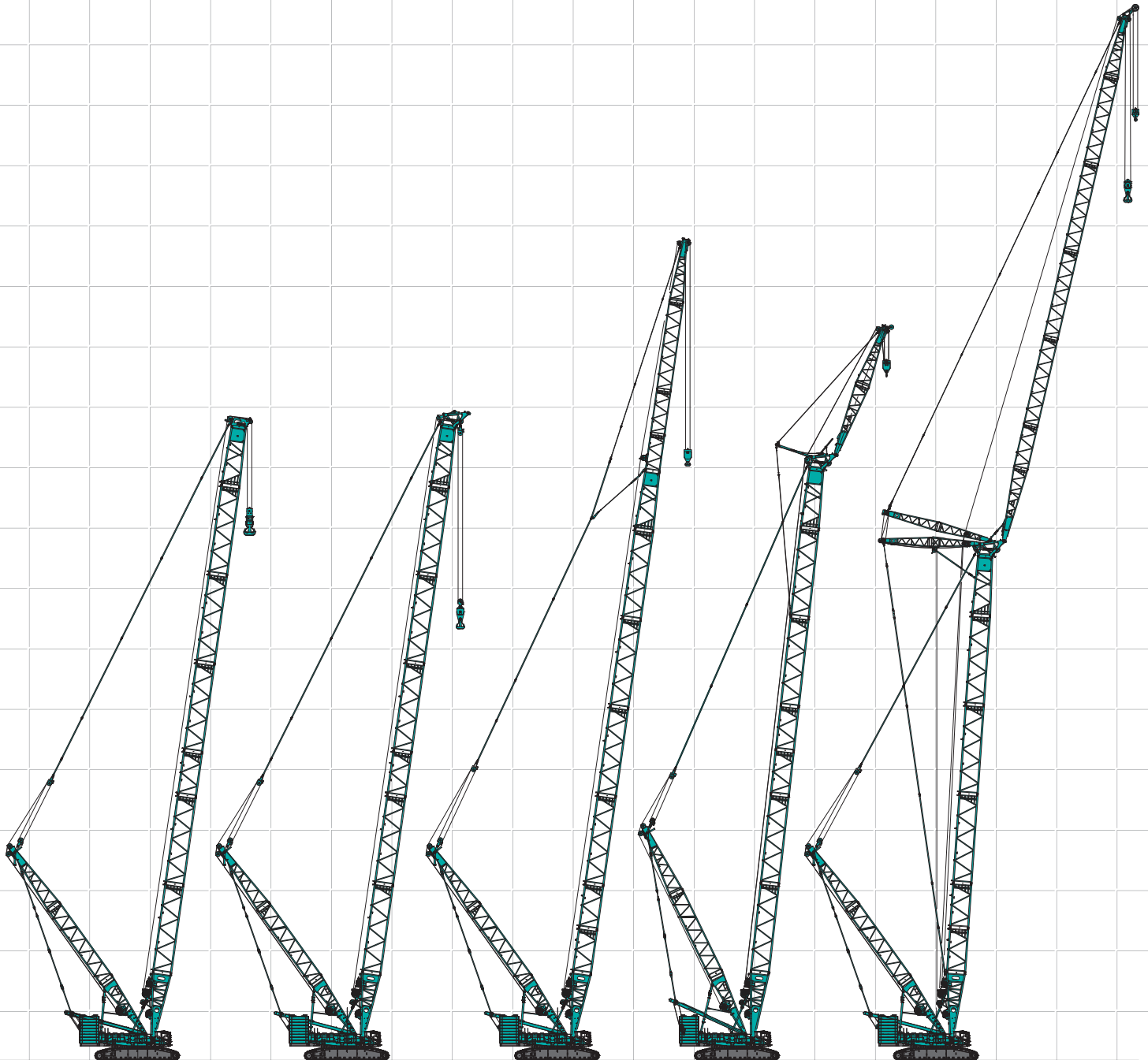

STD Luffing Jib

STD	Heavy Duty Crane Boom	Luffing Boom	Long Boom	Heavy Fixed Jib (Type A)	Luffing Jib
					
Max. Lifting Capacity:	450 t x 6.7 m	300 t x 10.0 m	98 t x 18.0 m	105 t x 20.0 m	195.1 t x 14.0 m
Max. Boom Length:	84 m	84 m	108 m	–	–
Max. Combination:	–	–	–	78 m + 18 m	60 m + 72 m

The following abbreviations are used throughout this catalog:  
 STD: Standard HL: Heavy Lift SHL: Super Heavy Lift



**HL Heavy Duty Crane Boom    HL Luffing Boom    HL Long Boom    HL Fixed Jib (Type B1)    HL Luffing Jib**

HL	Heavy Duty Crane Boom	Luffing Boom	Long Boom	Fixed Jib (Type B1)	Luffing Jib
					
Max. Lifting Capacity:	370 t x 8.3 m	300 t x 9.3 m	98 t x 20.0 m	120 t x 20.0 m	200 t x 14.4 m
Max. Boom Length:	84 m	84 m	108 m	-	-
Max. Combination:	-	-	-	78 m + 18 m	66 m + 72 m

# CONFIGURATION

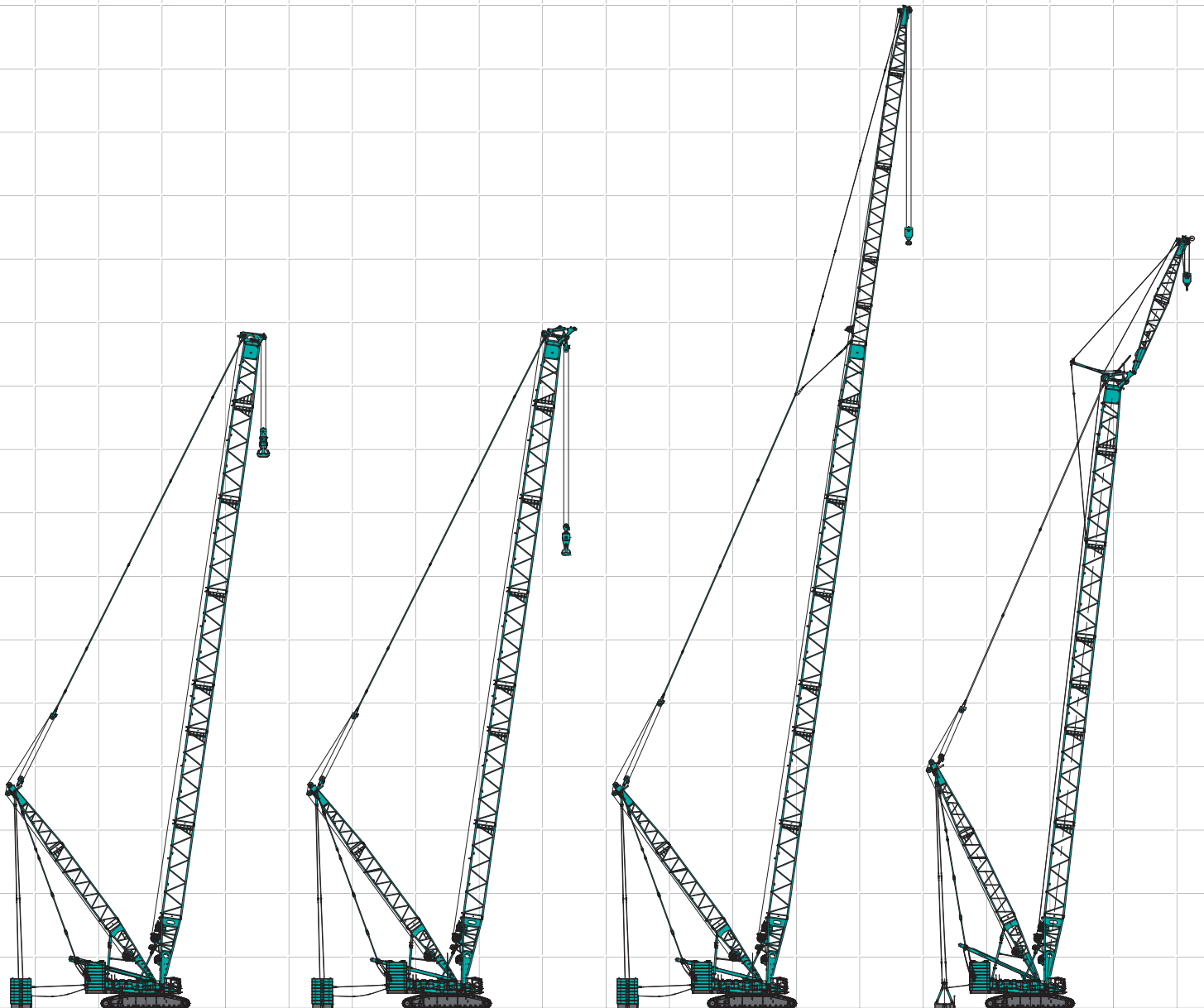

SHL Heavy Duty Crane Boom

SHL Luffing Boom

SHL Long Boom

SHL Heavy Fixed Jib (Type B2)



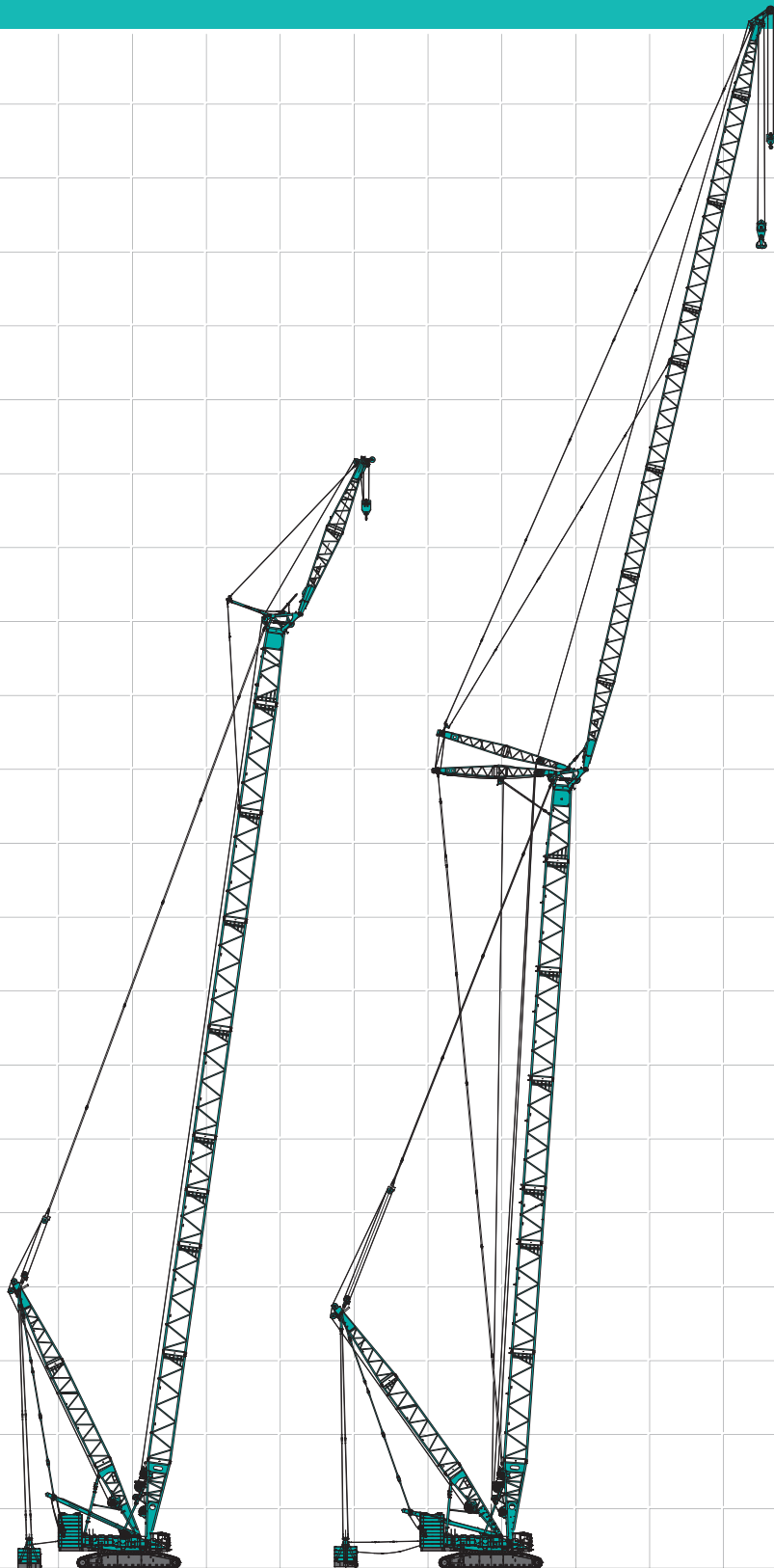

SHL	Heavy Duty Crane Boom	Luffing Boom	Long Boom	Heavy Fixed Jib (Type B2)
Max. Lifting Capacity:	550 t x 8.3 m	300 t x 20.0 m	98 t x 30.0 m	120 t x 20.0 m
Max. Boom Length:	84 m	84 m	126 m	-
Max. Combination:	-	-	-	78 m + 18 m





SHL Heavy Fixed Jib (Type C)

SHL Luffing Jib

SHL	Heavy Fixed Jib (Type C)	Luffing Jib
 		
Max. Lifting Capacity:	105 t x 30.0 m	200 t x 14.4 m
Max. Boom Length:	–	–
Max. Combination:	102 m + 18 m	84 m + 84 m

## CONTENTS

Configuration ..... 1  
 Specifications ..... 5  
 General Dimensions ..... 7

### STANDARD

Boom and Jib Arrangements ..... 9  
 Working Ranges ..... 12  
 Crane Boom Supplemental Data ..... 19  
 Heavy Fixed Jib Supplemental Data ..... 21  
 Luffing Jib Supplemental Data ..... 23  
 Heavy Duty Crane Boom Lifting Capacities ..... 27  
 Heavy Fixed Jib Lifting Capacities ..... 27  
 Long Boom Lifting Capacities ..... 27  
 Luffing Boom Lifting Capacities ..... 28  
 Luffing Jib Lifting Capacities ..... 29

### HEAVY LIFT

Boom and Jib Arrangements ..... 33  
 Working Ranges ..... 36  
 Heavy Duty Crane Boom Lifting Capacities ..... 43  
 Long Boom Lifting Capacities ..... 44  
 Heavy Fixed Jib Lifting Capacities ..... 44  
 Luffing Boom Lifting Capacities ..... 45  
 Luffing Jib Lifting Capacities ..... 46

### SUPER HEAVY LIFT

Boom and Jib Arrangements ..... 49  
 Working Ranges ..... 53  
 Heavy Duty Crane Boom Lifting Capacities ..... 61  
 Long Boom Lifting Capacities ..... 62  
 Heavy Fixed Jib Lifting Capacities ..... 63  
 Luffing Boom Lifting Capacities ..... 64  
 Luffing Jib Lifting Capacities ..... 65

Transportation Plan ..... 75

Parts and Attachments ..... 77

# SPECIFICATIONS



## Power Plant

**Model:** Hino diesel engine E13C-WY

**Type:** Water-cooled, direct fuel injection, with turbocharger  
Exhaust level is equivalent with NRMM (Europe) Stage III A / US EPA Tier3.

**Displacement:** 12.913 L

**Rated Power:** 320 kW/2,000 min<sup>-1</sup> (Max Power: 330 kW/1,800 min<sup>-1</sup>)

**Max. torque:** 1,930 N-m/1,300 min<sup>-1</sup>

**Cooling system:** Water-cooled

**Starter:** 24 V / 6 kW

**Radiator:** Corrugated type core, thermostatically controlled

**Air cleaner:** Dry type with replaceable paper element

**Throttle:** Twist grip type hand throttle, electrically actuated

**Fuel filter:** Replaceable paper element with water separator.

**Batteries:** Two 12V x 136Ah/5HR capacity batteries, parallel connected.

**Fuel tank capacity:** 600 L



## Hydraulic System

Seven variable displacement piston pumps are driven by heavy-duty pump drive. Two variable displacement pumps are used in H1 (main hook hoist) and right hand side propel circuit. Two variable displacement pumps are used in H2 (auxiliary hook hoist) and left hand side propel circuit. One of the other two pumps is used in W1 (boom), W2 (jib) or W3 (SHL mast) hoist circuit, and the other is used in the swing circuit. One displacement piston pump is used for W1 or W3 hoist speed up.

**Control:** Full-flow hydraulic control system for infinitely variable pressure to all winches, propel and swing.

Controls respond instantly to the touch, delivering smooth function operation.

**Cooling:** Oil-to-air heat exchanger (plate-fin type)

**Filtration:** Full-flow and bypass type with replaceable element

**Max. relief valve pressure:** 32.0 MPa {326 kgf/cm<sup>2</sup>}

**Oil Quantity (at the reference level):** 710 L



## Boom Hoisting System

Powered by a hydraulic motor through a planetary reducer.

**Brake:** A spring-set, hydraulically released multiple-disc brake is mounted on the boom hoist motor and operated through a counter-balance valve.

**Drum lock:** External ratchet for locking drum.

**Drum:** Double drum, grooved for 28 mm dia. wire rope.

**Line speed:** Single line on first drum layer

**Hoisting/Lowering:** 28 to 2 m/min x 2

**Boom hoist reeving:** 30 parts of 28 mm dia. high strength wire rope

**Boom backstops:** Required for all boom lengths



## Load Hoist System

H1 and H2 drums for load hoist powered by a hydraulic variable plunger motors, driven through planetary reducers.

**Brake:** A spring-set, hydraulically released multiple-disc brake is mounted on the hoist motor and operated through a counterbalance valve.

**Drum lock:** External ratchet for locking drum.

**Drums:**

**H1 and H2:**

640 mm P.C.D. x 1,367 mm Lg. wide drum, grooved for 28 mm wire rope. Rope capacity is 830 m storage length.

Note: Rope lengths listed above denote drum capacity and may differ from actual rope lengths supplied when machinery is shipped.

**Line speed:** 110 to 3 m/min

Single line on the first layer

**Rated line pull:** 137 kN {14.0 tf}



## Swing System

Swing unit is powered by hydraulic motor driving spur gears through planetary reducers (4 sets), the swing system provides 360° rotation.

**Swing parking brakes:** A spring-set, hydraulically released multiple-disc brake is mounted on swing motor.

**Swing circle:** Triple-row roller bearing with an integral internally cut swing gear.

**Swing speed:** 0.9 min<sup>-1</sup> {rpm}



## Upper Structure

Torsion-free precision machined upper frame. All components are located clearly and service friendly. Engine with low noise level.



## Cab & Control

Totally enclosed, full vision cab with safety glass, fully adjustable, can be tilted up to 15 degree, high backed seat with a head-rest and armrests, and intermittent wiper and window washer (sky light and front window.)

**Cab fittings:**

Air conditioner, convenient compartment (for tool), cup holder, ashtray, cigarette lighter, sun visor, roof blind, tinted glass, floor mat, foot-rest, shoe tray

**Controls:**

Five adjustable levers for all winches and swing controls



## Lower Structure

Steel-welded carbody with axles. Crawler assemblies are designed with quick disconnect feature for individual removal as a unit from axles. Crawler belt tension is maintained by hydraulic jack force on the track-adjusting bearing block.

**Crawler drive:** Two independent hydraulic propel drive is built into each crawler side frame. Each drive consists of a hydraulic motor propelling a driving tumbler through a planetary gear box. Hydraulic motor and gear box are built into the crawler side frame within the shoe width.

**Crawler brakes:** Spring-set, hydraulically released parking brakes are built into each propel drive.

**Steering mechanism:** A hydraulic propel system provides both skid steering (driving one track only) and counter-rotating steering (driving each track in opposite directions).

**Track rollers:** Sealed track rollers.

**Shoes (flat):** 1,500 mm wide each crawler

**Max. travel speed:** 1.0/0.6 km/h

**Max. gradeability:** 20%



## Weight

Including base machine, counterweights =200 metric ton, carbody weights = 50 metric ton, 24 m standard heavy duty boom and 550 metric ton hook block. Not include quick connection device and upper translifter.

**Weight:** Approx. 456 metric ton

**Ground pressure:** 142 kPa {1.5 kgf/cm<sup>2</sup>}



## Attachment

### Boom and Jib:

Welded lattice construction using tubular, high-tensile steel chords with pin connections between sections.

### Boom and Jib Length

	Min. Length (Min. Combination)	Max. Length (Max. Combination)
<b>STANDARD</b>		
Heavy Duty Boom	24 m	84 m
Luffing Boom	30 m	84 m
Long Boom	90 m	108 m
Heavy Fixed Jib	66 m + 18 m	78 m + 18 m
Luffing Jib	30 m + 24 m	60 m + 72 m
<b>HEAVY LIFT</b>		
Heavy Duty Boom	36 m	84 m
Luffing Boom	36 m	84 m
Long Boom	90 m	108 m
Heavy Fixed Jib	66 m + 18 m	78 m + 18 m
Luffing Jib	36 m + 24 m	66 m + 72 m
<b>SUPER HEAVY LIFT</b>		
Heavy Duty Boom	36 m	84 m
Luffing Boom	36 m	84 m
Long Boom	90m	126 m
Heavy Fixed Jib	66 m + 18 m	78 m + 18 m
	84 m + 18 m	102 m + 18 m
Luffing Jib	36 m + 24 m	84 m + 84 m

## Main Specifications (Model: SL6000S)

Lift Enhancer	STD	HL	SHL	
HL Mast	-	30 m	30 m	
Additional Weight	-	-	to 250 t	
<b>Heavy Duty Crane Boom</b>				
Max. Lifting Capacity	450 t	370 t	550 t	
	6.7 m	8.3 m	8.3 m	
Length	24 to 84 m	36 to 84 m	36 to 84 m	
<b>Luffing Boom</b>				
Max. Lifting Capacity	300 t	300 t	300 t	
	9.3 m	9.3 m	10.2m	
Length	30 to 84 m	36 to 84 m	36 to 84 m	
<b>Long Boom</b>				
Max. Lifting Capacity	98 t	98 t	98 t	
	18 m	20 m	30 m	
Length	90 to 108 m	90 to 108 m	90 to 126 m	
<b>Heavy Fixed Jib</b>				
Max. Lifting Capacity	105 t	120 t	*1	*2
	20.0 m	20.0 m	20 m	30m
Max. Combination (Boom) (Jib)	78 m	78 m	78 m	102 m
	18 m	18 m	18 m	18 m
<b>Luffing Jib</b>				
Max. Lifting Capacity	195.1 t	200 t	200 t	
	14 m	14.4 m	14.4 m	
Max. Combination (Boom) (Jib)	60 m	66 m	84 m	
	72 m	72 m	84 m	
Luffing Angle	66° to 86°			

<b>Power Plant</b>	
Model	Hino E13C-WY
Engine Output	320 kW/2,000 min <sup>-1</sup> {rpm}
Fuel Tank Capacity	600 L
<b>Hoist Winch (H1, H2)</b>	
Max. Line Speed	110 m/min (1st layer)
Rated Line Pull (Single line)	137 kN {14.0 tf}
Wire Rope Diameter	28 mm
Wire Rope Length	830 m
<b>Working Speed</b>	
Swing	0.9 min <sup>-1</sup> {rpm}
Travel	1.0/0.6 km/h
<b>Hydraulic System</b>	
Pumps	7 variable displacement
Max. Pressure	32 MPa {326 kgf/cm <sup>2</sup> }
Oil Quantity (at the reference level)	710 L
<b>Weight</b>	
Working Weight* <sup>3</sup>	Approx. 456 t
Ground Pressure* <sup>3</sup>	142 kPa {1.5 kgf/cm <sup>2</sup> }
Counterweight	Upper: 200 metric tons
	Lower: 50 metric tons

\*1 Heavy Fixed Jib Type B2

\*2 Heavy Fixed Jib Type C

\*3 Including base machine, counterweights =200 metric ton, carbody weights = 50 metric ton, 24 m boom with heavy boom tip and 550 metric ton hook block. Not include quick connection device and upper translifter.

# GENERAL DIMENSIONS

## Crane Boom

Unit: mm

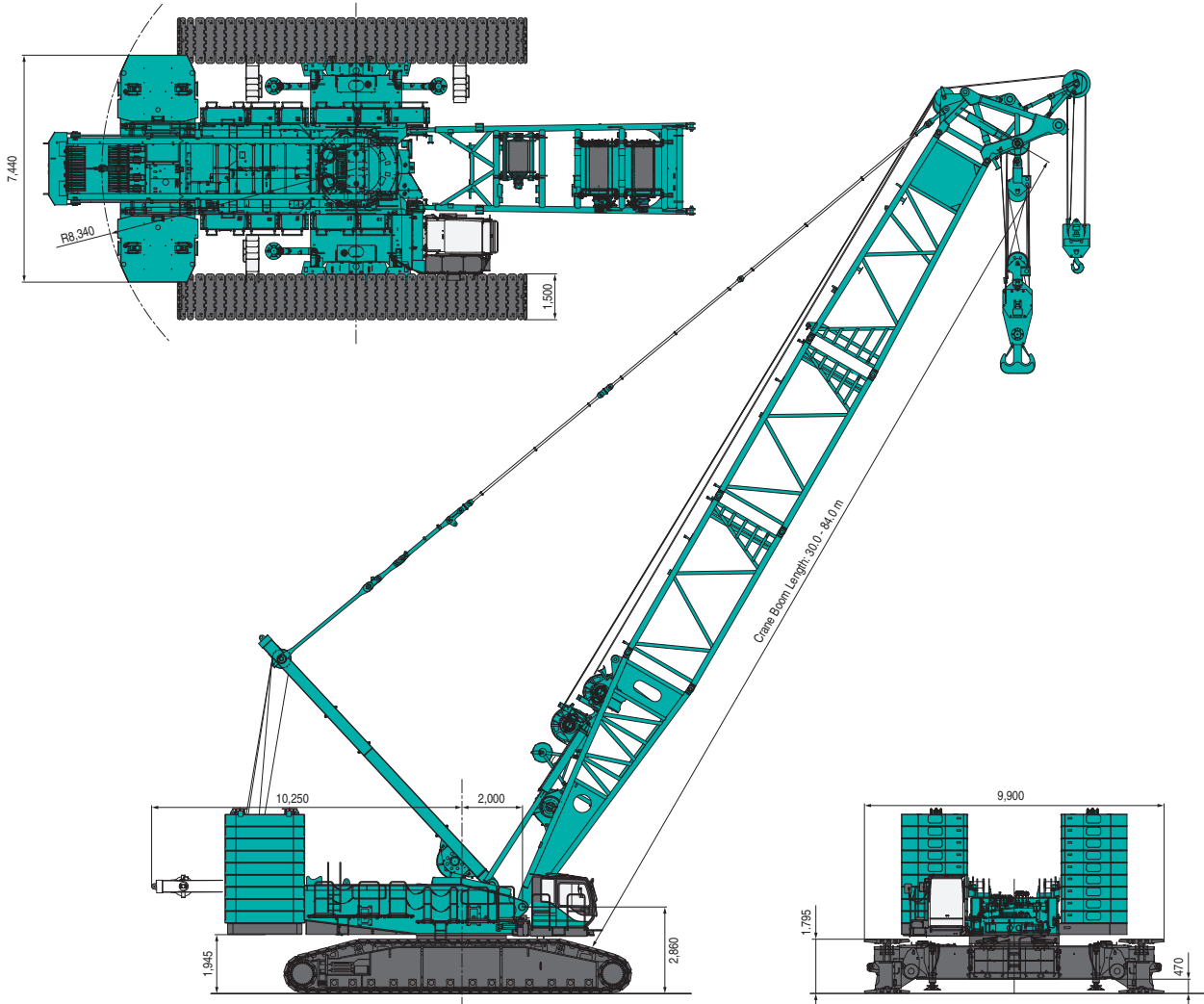

## Lift Enhancer

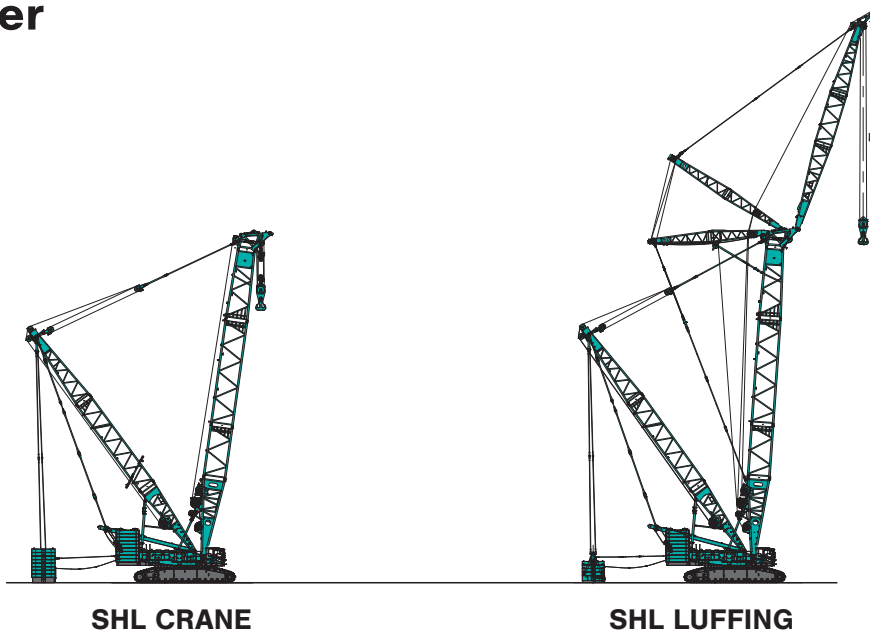

# Luffing Jib

Unit: mm

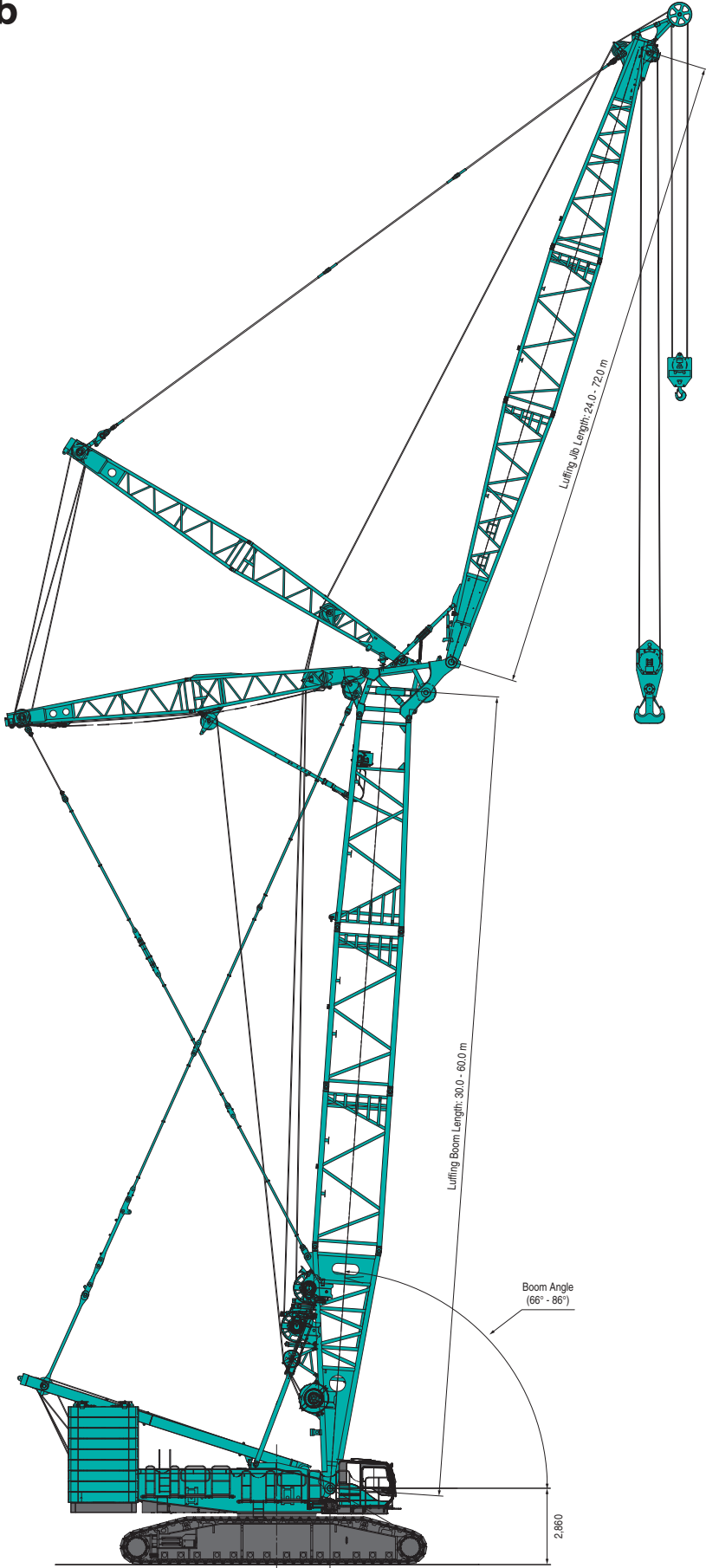

## BOOM AND JIB ARRANGEMENTS



### Heavy Duty Crane Boom Arrangements



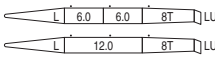
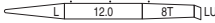
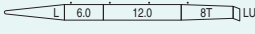
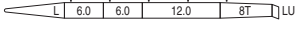
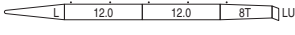
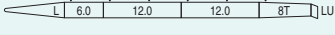
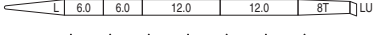
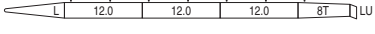
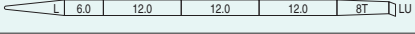
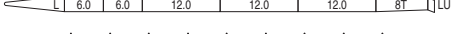
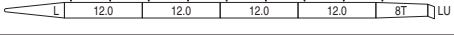

Boom length m (ft)	Boom arrangement
24 (79)	
30 (98)	※ 
36 (118)	※
42 (138)	※ 
48 (157)	※
54 (177)	※ 
60 (197)	※
66 (217)	※ 
72 (236)	※
78 (256)	※ 
84 (276)	※

Symbol	Boom Length	Remarks
	9.0 m (29.5 ft)	Boom Base
	8.0 m (26.2 ft)	Taper Boom Insert
	6.0 m (19.7 ft)	Boom Insert
	12.0 m (39.4 ft)	Boom Insert
	1.0 m (3.3 ft)	Heavy Boom Tip

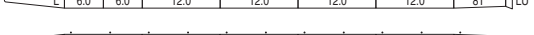
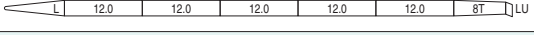
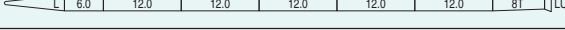
※ indicates the most flexible combination of insert heavy duty booms, which can be modified to form all shorter heavy duty boom arrangements.

# Luffing Boom Arrangements for Crane







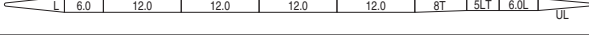
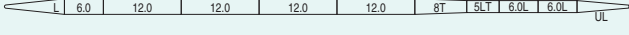
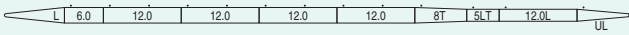
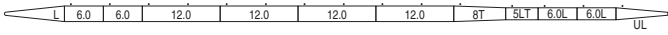
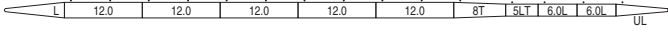
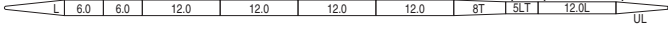
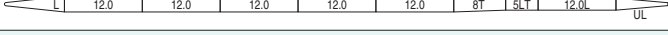
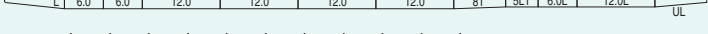
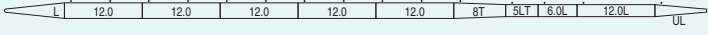

Boom length m (ft)	Boom arrangement
30 (98)	※  
36 (118)	※ 
42 (138)	※  
48 (157)	※ 
54 (177)	※  
60 (197)	※ 
66 (217)	※  
72 (236)	※ 
78 (256)	※  
84 (276)	※ 

Symbol	Boom Length	Remarks
	9.0 m (29.5 ft)	Boom Base
	8.0 m (26.2 ft)	Taper Boom Insert
	6.0 m (19.7 ft)	Boom Insert
	12.0 m (39.4 ft)	Boom Insert
	1.0 m (3.3 ft)	Luffing Boom Tip

※ indicates the most flexible combination of insert luffing booms, which can be modified to form all shorter luffing boom arrangements.

# Long Boom Arrangements

Boom length m (ft)	Boom arrangement
90 (295)	
96 (315)	※  
102 (335)	※    
108 (354)	※  





Symbol	Boom Length	Remarks
	9.0 m (29.5 ft)	Boom Base
	8.0 m (26.2 ft)	Taper Boom Insert
	6.0 m (19.7 ft)	Boom Insert
	12.0 m (39.4 ft)	Boom Insert
	5.0 m (16.4 ft)	Special Long Boom Insert
	6.0 m (19.7 ft)	Long Boom Insert
	12.0 m (39.4 ft)	Long Boom Insert
	8.0 m (26.2 ft)	Long Boom Tip

※ indicates the most flexible combination of insert long booms, which can be modified to form all shorter long boom arrangements.

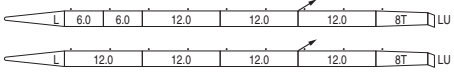
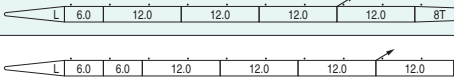
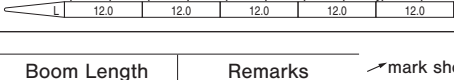

## Heavy Fixed Jib Boom Arrangements



Boom length m (ft)	Boom arrangement
66 (217)	※ 
72 (236)	※ 
78 (256)	※ 

Symbol	Boom Length	Remarks
	9.0 m (29.5 ft)	Boom Base
	8.0 m (26.2 ft)	Taper Boom Insert
	6.0 m (19.7 ft)	Boom Insert
	12.0 m (39.4 ft)	Boom Insert
	1.0 m (3.3 ft)	Boom Tip



↗ mark shows the guy line installing position when the fixed jib is used.  
 ※ indicates the most flexible combination of insert luffing booms, which can be modified to form all shorter luffing boom arrangements.



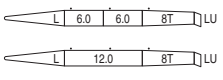
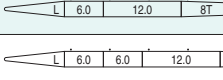
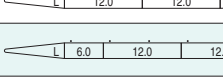
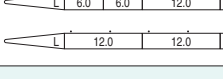
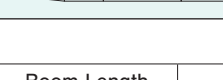

## Heavy Fixed Jib Arrangements

Jib length m (ft)	Jib arrangement
18 (59)	

Symbol	Jib Length	Remarks
	10.0 m (32.8 ft)	Jib Base
	8.0 m (26.2 ft)	Jib Tip

## Luffing Boom Arrangements for Luffing





Boom length m (ft)	Boom arrangement
30 (98)	※ 
36 (118)	※ 
42 (138)	※ 
48 (157)	※ 
54 (177)	※ 
60 (197)	※ 

Symbol	Boom Length	Remarks
	9.0 m (29.5 ft)	Boom Base
	8.0 m (26.2 ft)	Taper Boom Insert
	6.0 m (19.7 ft)	Boom Insert
	12.0 m (39.4 ft)	Boom Insert
	1.0 m (3.3 ft)	Boom Tip

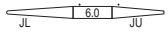
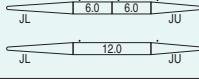
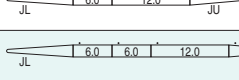
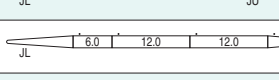
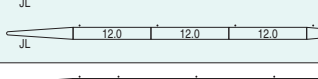
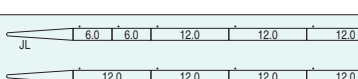
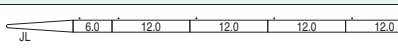
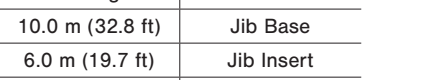
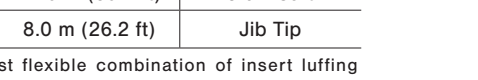
※ indicates the most flexible combination of insert luffing booms, which can be modified to form all shorter luffing boom arrangements.

## Luffing Jib Arrangements

Jib length m (ft)	Jib arrangement
24 (79)	
30 (98)	※ 
36 (118)	※ 
42 (138)	※ 
48 (157)	※ 
54 (177)	※ 
60 (197)	※ 
66 (217)	※ 
72 (236)	※ 

Symbol	Jib Length	Remarks
	10.0 m (32.8 ft)	Jib Base
	6.0 m (19.7 ft)	Jib Insert
	12.0 m (39.4 ft)	Jib Insert
	8.0 m (26.2 ft)	Jib Tip

※ indicates the most flexible combination of insert luffing jibs, which can be modified to form all shorter luffing jib arrangements.

# WORKING RANGES

## Heavy Duty Crane Boom

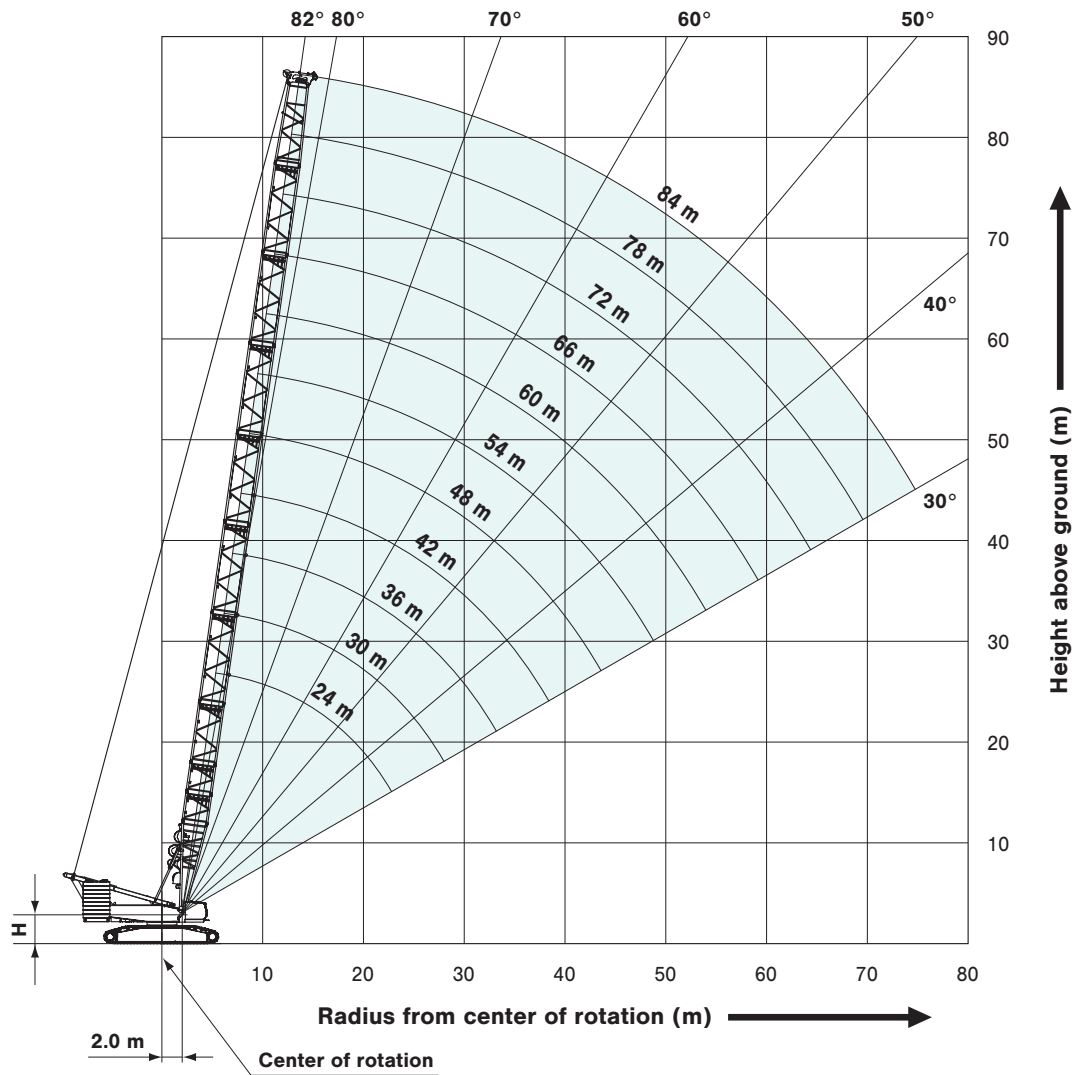

H=2.86 m Without quick connection ring  
H=3.08 m With quick connection ring

# STANDARD

## WORKING RANGES

### Luffing Boom

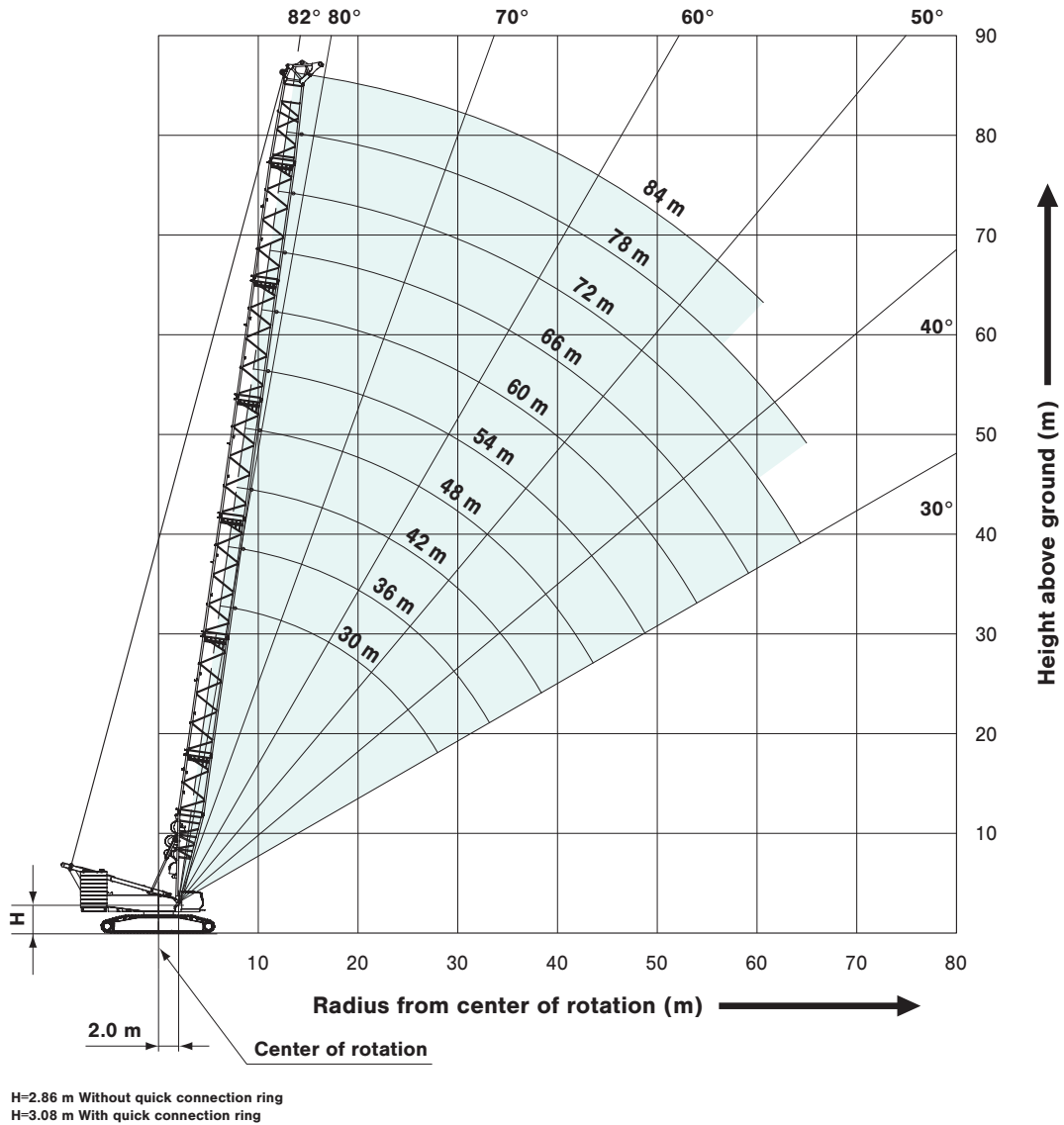

# Long Boom

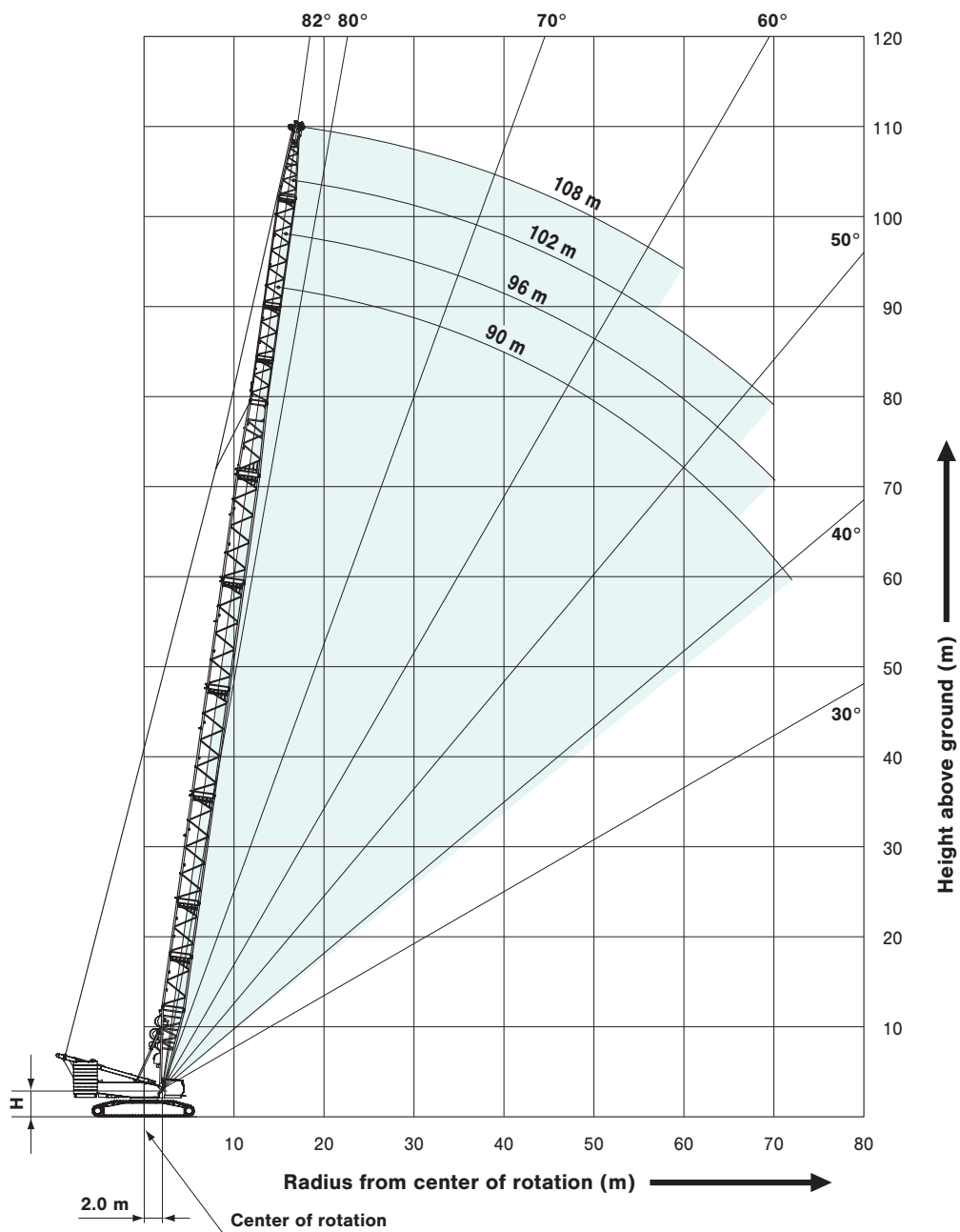

H=2.86 m Without quick connection ring  
H=3.08 m With quick connection ring

## WORKING RANGES

### Heavy Fixed Jib (Type A)

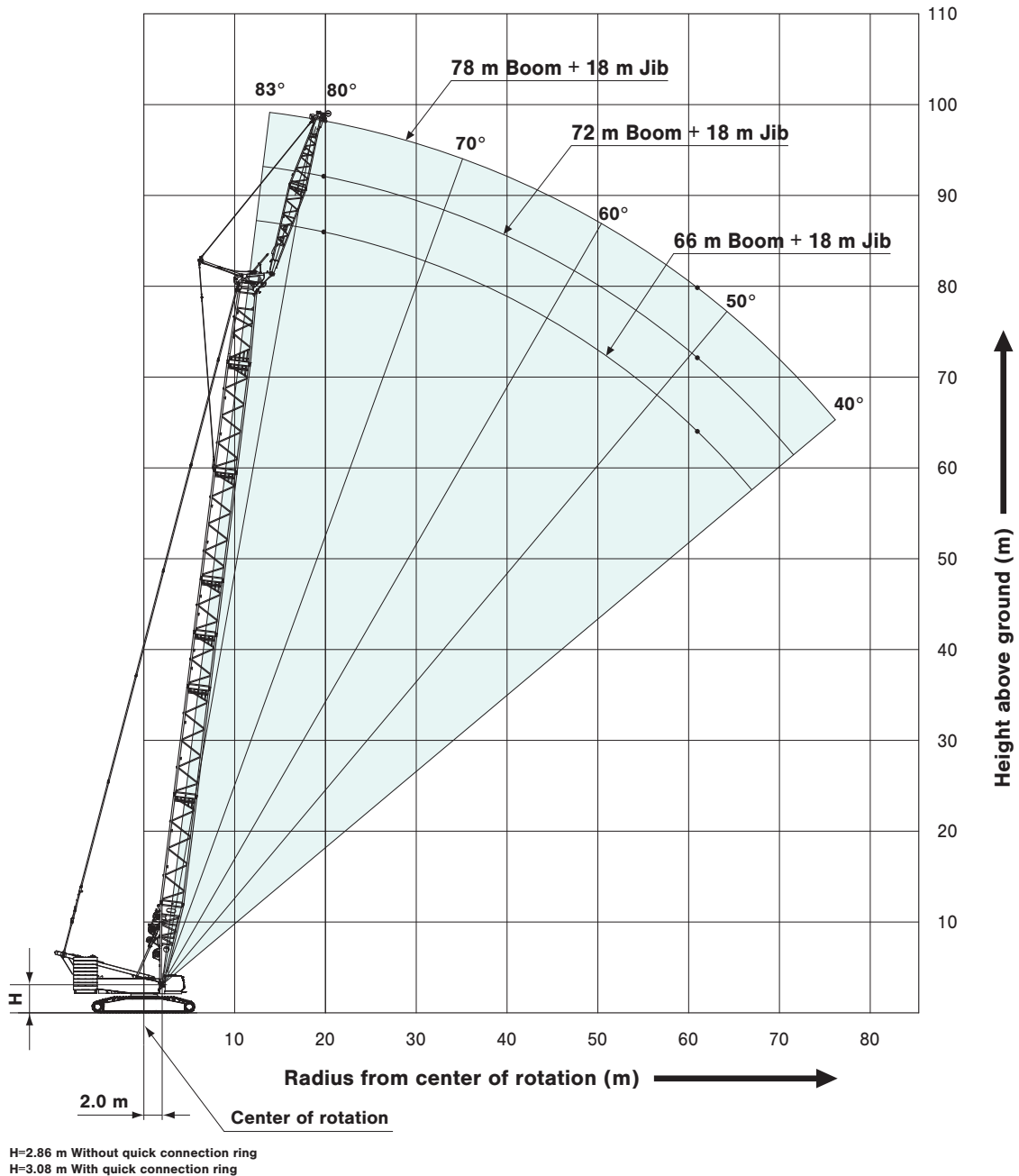

# Luffing Jib

Boom Angle: 86°

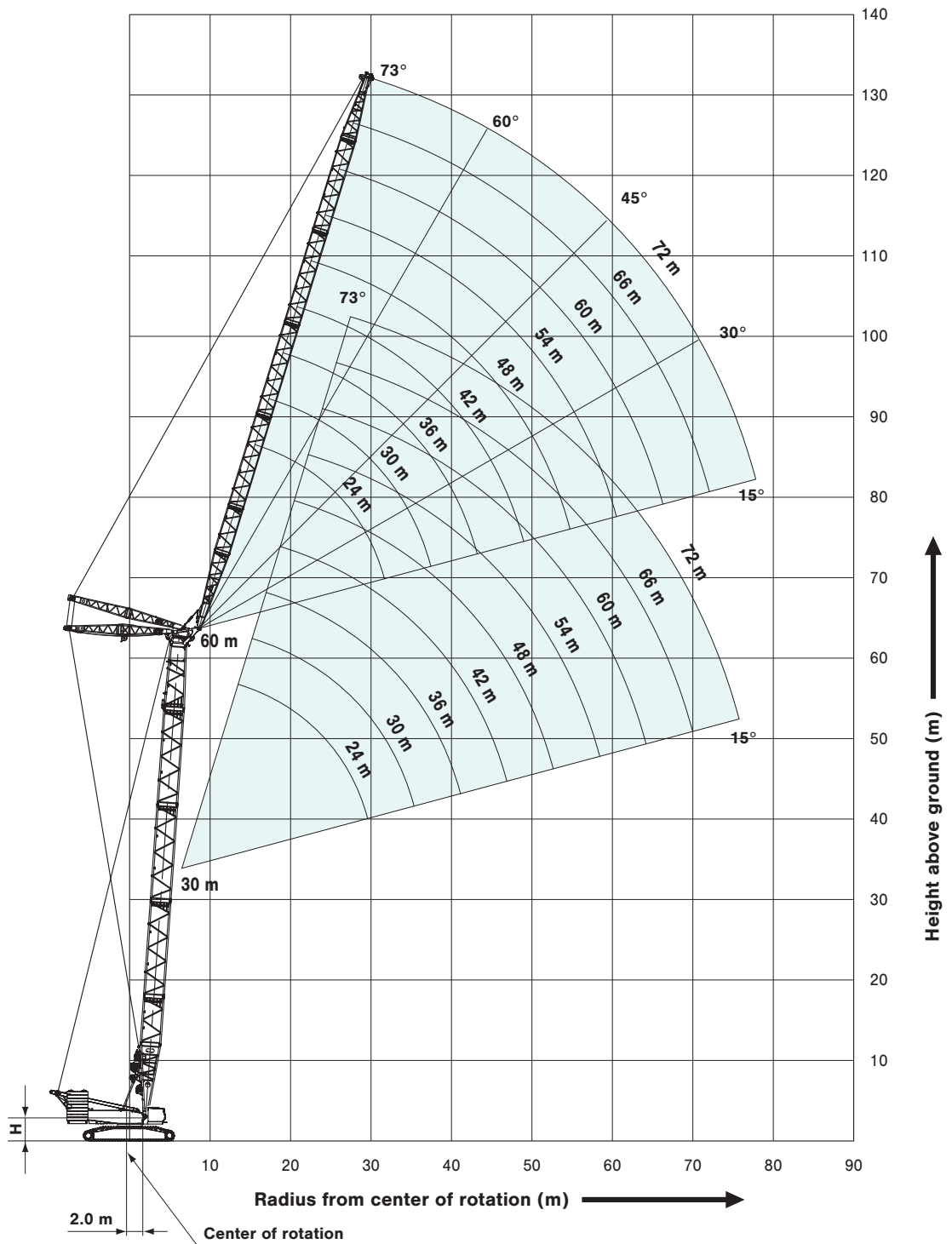

H=2.86 m Without quick connection ring  
 H=3.08 m With quick connection ring

# STANDARD

## WORKING RANGES

### Luffing Jib

Boom Angle: 76°

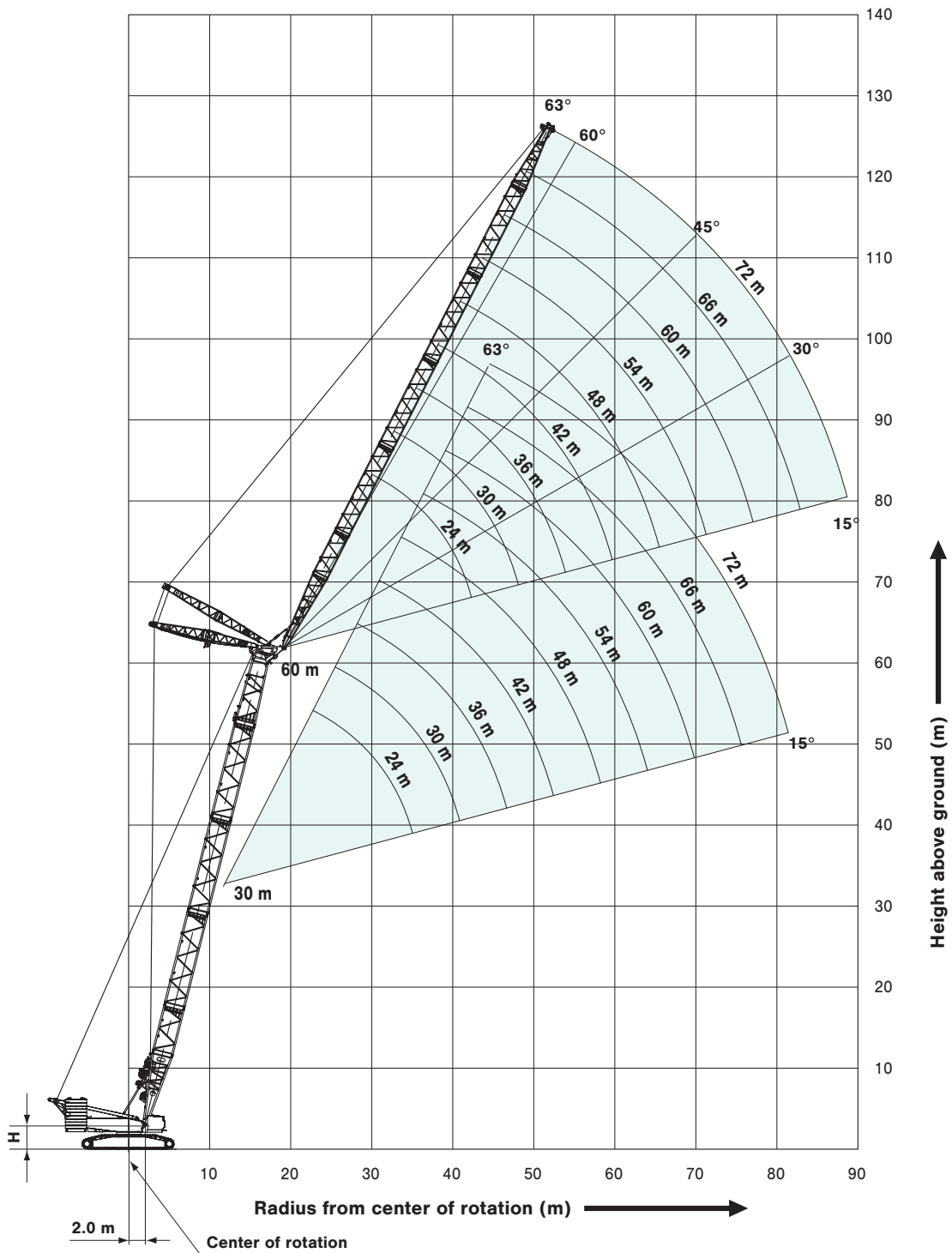

H=2.86 m Without quick connection ring  
H=3.08 m With quick connection ring



# Luffing Jib

Boom Angle:  $66^\circ$

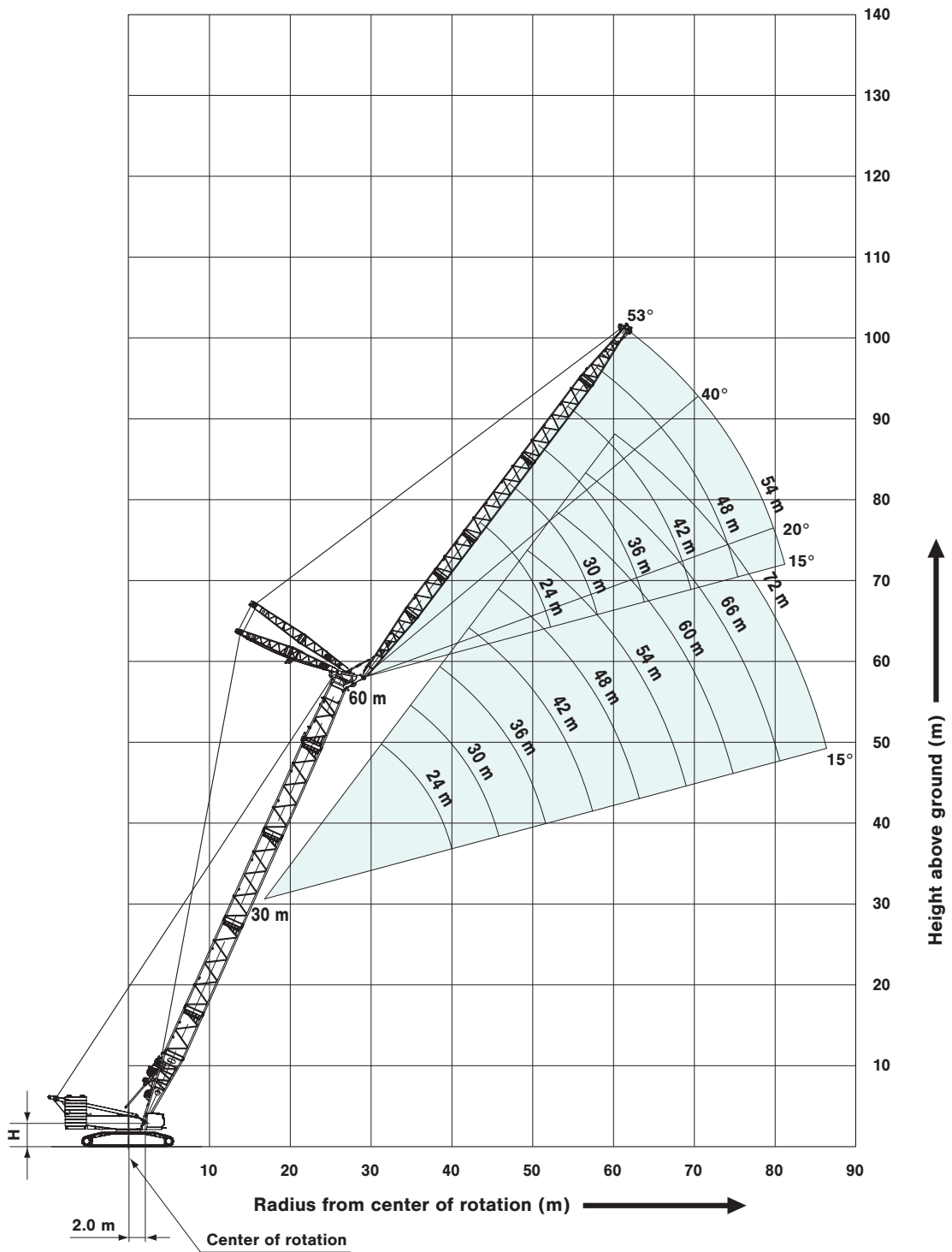

H=2.86 m Without quick connection ring  
 H=3.08 m With quick connection ring

# CRANE BOOM SUPPLEMENTAL DATA

1. Ratings according to EN13000.
2. Operating radius is the horizontal distance from centerline of rotation to a vertical line through the center of gravity of the load.
3. Deduct weight of hook block(s), slings and all other load handling accessories from main boom ratings shown.
4. Ratings shown are based on freely suspended loads and make no allowance for such factors as wind effect on lifted load, ground conditions, out-of-level, operating speeds or any other condition that could be detrimental to the safe operation of this equipment. The operator, therefore, has the responsibility to judge the existing conditions and reduce lifted loads and operating speeds accordingly.
5. Ratings are for operation on a firm and level surface, up to 1% gradient.
6. At radii and boom lengths where no ratings are shown on chart, operation is not intended nor approved.
7. Boom inserts, guy link and guy lines must be arranged as shown in the "OPERATOR'S MANUAL".
8. Boom hoist reeving is 30 part line. HL/SHL boom hoist reeving is 18 part line.
9. Boom backstops are required for all boom lengths.
10. The boom should be erected over the front of the crawlers, not laterally.
11. Ratings inside of boxes  are limited by strength of materials.
12. When erecting and lowering the boom length of 102 m or over, the blocks for erection must be placed at the end of the crawlers. (for STD MAST)
13. When erecting and lowering the boom length of 108 m, the blocks for erection must be placed at the end of the crawlers. (for HL MAST).
14. The minimum rated show below.

Minimum Rated Load		
Heavy Crane	STD Crane	Long Crane
12.1 ton	7.7 ton	6.2 ton

## 15. (Main Boom Lifting)

The total load that can be lifted is the value for weight of hook block, slings, and all other load handling accessories deducted from main boom ratings shown.

## 16. (Main Boom Lifting with Auxiliary Sheave Frame)

The total load that can be lifted is weight of auxiliary sheave frame, hook block(s), slings, and all other load handling accessories deducted from main boom ratings shown.

Deduction auxiliary sheave frame		
Heavy Crane	STD Crane	Long Crane
0.7 ton	0.7 ton	0.7 ton

## 17. (Auxiliary Sheave Lifting)

The total load that can be lifted is weight of auxiliary sheave frame, hook block(s), slings, and all other load handling accessories deducted from main boom ratings shown.

Deduction auxiliary sheave frame		
Heavy Crane	STD Crane	Long Crane
0.7 ton	0.7 ton	0.7 ton

18. Ratings shown, but it should not exceed 14.0 ton in case of one reeve. and it should not exceed 28.0 ton in case of two reeves.
19. Auxiliary sheave ratings at any radius from center of rotation are the same as crane ratings shown in table for main boom when operated at the same radius. But maximum angle is the same main boom maximum angle.
20. Boom lengths for auxiliary sheave mounting show below.

	Mast for STD	Mast for HL	Mast for SHL
Heavy Crane	NONE	NONE	NONE

	Mast for STD	Mast for HL	Mast for SHL
STD Crane	30 m to 84 m	36 m to 84 m	36 m to 84 m

	Mast for STD	Mast for HL	Mast for SHL
Long Crane	90 m to 102 m	90 m to 108 m	90 m to 120 m

21. Maximum hoist load for number of reeving parts of line for hoist rope.

**Main Hoist Loads (Single Drum)**

No. of Parts of Line	1	2	3	4	5
Maximum Loads (kN)	137	275	412	549	686
Maximum Loads (t)	14.0	28.0	42.0	56.0	70.0

No. of Parts of Line	6	7	8	9	10
Maximum Loads (kN)	824	961	1,098	1,236	1,373
Maximum Loads (t)	84.0	98.0	112.0	126.0	140.0

No. of Parts of Line	11	12	13	14	15
Maximum Loads (kN)	1,491	1,608	1,706	1,804	1,883
Maximum Loads (t)	152.0	164.0	174.0	184.0	192.0

No. of Parts of Line	16
Maximum Loads (kN)	1,961
Maximum Loads (t)	200.0

**Main Hoist Loads for Heavy Boom (Double Drum)**

No. of Parts of Line	8	12	16	20	24
Maximum Loads (kN)	1,098	1,608	2,157	2,746	3,295
Maximum Loads (t)	112.0	164.0	220.0	280.0	336.0

No. of Parts of Line	28	36	44
Maximum Loads (kN)	3,628	4,413	5,394
Maximum Loads (t)	370.0	450.0	550.0

**Main Hoist Loads for STD Boom (Double Drum)**

No. of Parts of Line	8	12	16	20	24
Maximum Loads (kN)	1,098	1,608	2,157	2,746	2,942
Maximum Loads (t)	112.0	164.0	220.0	280.0	300.0

**Auxiliary Hoist Loads**

No. of Parts of Line	1	2
Maximum Loads (kN)	137	275
Maximum Loads (t)	14.0	28.0

22. Weight of hook block

Weight of hook block				
Hook block	550/450 ton	300 ton (with hanger sheave)	200 ton (w/o hanger sheave)	120 ton
Weight (t)	11.7	9.9 (*1)	7.1 (*2)	4.5

Weight of hook block			
Hook block	70 ton	40 ton	14 ton Ball hook
Weight (t)	3.1	2.0	0.9

\*1: 7.82 ton: when hanger sheave is not equipped.

\*2: To reeve 11 parts line or over hanger sheave (2 t) is not required.

23. The rated load of the work when the strut guy line is installed on the boom upper surface is value in the rated load chart minus the value in the table below.

Heavy crane, STD crane					
Boom length(m)	24	30	36	42	48
Subtract load(t)	0.4	0.6	0.7	0.9	1.1

Heavy crane, STD crane					
Boom length(m)	54	60	66	72	78
Subtract load(t)	1.2	1.4	1.6	1.7	1.9

Heavy crane, STD crane	
Boom length(m)	84
Subtract load(t)	2.1

Long crane					
Boom length(m)	90	96	102	108	114
Subtract load(t)	1.7	1.7	1.9	1.9	2.1

Long crane		
Boom length(m)	120	126
Subtract load(t)	2.1	2.1

Operation of this equipment in excess of rated loads or disregard of instruction voids the warranty.

# HEAVY FIXED JIB SUPPLEMENTAL DATA

1. Ratings according to EN13000.
2. Rated loads included in the charts are the maximum allowable freely suspended loads at a given boom length, boom angle and load radius, and have been determined for the machine standing level on firm supporting surface under ideal operating conditions. The user must limit or de-rate rated loads to allow for adverse conditions (such as soft or uneven ground, out-of-level conditions, wind, side loads, pendulum action, jerking or sudden stopping of loads, inexperience of personnel, multiple machine lifts, and traveling with a load).
3. Rated loads do not exceed 75% of minimum tipping loads. Ratings inside of boxes  are limited by strength of material or other factor except machine stability.
4. The machine must be reeved and set-up as stated in the operation manual and all the instruction manuals. If these manuals are missing, obtain replacements.
  - Boom backstops are required for all boom lengths.
  - The crane must be leveled to within 1% on a firm supporting surface.
5. Do not attempt to lift where no radius on load is listed as crane may tip or collapse.
6. Attempting to lift more than rated loads may cause machine to tip or collapse. Do not tip machine to determine rated loads.
7. Weight of hooks, hook blocks, slings and other lifting devices are a part of the total load. Their total weight must be subtracted from the rated load to obtain the weight that can be lifted.

## 8. Configuration

Symbol	Counterweight	Carbody Weight	HL Mast Radius	Pallet Weight
A	200 t	50 t	NONE	NONE
B1	200 t	50 t	11 m	NONE
B2	200 t	50 t	11 m	10 t
C	200 t	50 t	11 m	130 t

## 9. Boom and Heavy Fixed Jib combinations

Boom	Jib	Type of configuration			
		A	B1	B2	C
66 m	18 m	Y	Y	Y	N
72 m	18 m	Y	Y	Y	
78 m	18 m	Y	Y	Y	
84 m	18 m	N			Y
90 m	18 m				Y
96 m	18 m				Y
102 m	18 m				Y

Y: Applicable boom and heavy fixed jib combination  
 N: Not applicable boom and heavy fixed jib combination

## 10. The boom should erected lowered over the front of the crawlers

Boom	Jib	Type of configuration				
		A	B1	B2	C	
66 m	18 m	N	N	N	/	
72 m	18 m	N	N	N		
78 m	18 m	Y	N	N		
84 m	18 m					N
90 m	18 m					N
96 m	18 m					N
102 m	18 m					N

Y: the blocks must be placed at the end of the crawlers for erection and lowering.

N: the blocks is not needed for erection and lowering.

11. To prevent the boom from leaning toward backward, the own weight of hook block attached to heavy fixed jib point must be equal to or more than 4.5 t.
12. Maximum hoist load for number of reeving parts of line for hoist rope.

### Main Boom Hoist Loads (Double Drum)

No. of Parts of Line	8(2x4)	10(2x5)
Maximum Loads (kN)	1,098	1,177
Maximum Loads (t)	112.0	120.0

### Main Boom Hoist Loads (Single Drum)

No. of Parts of Line	1	2	3	4	5
Maximum Loads (kN)	137	275	412	549	686
Maximum Loads (t)	14.0	28.0	42.0	50.0	70.0

No. of Parts of Line	6	7	8
Maximum Loads (kN)	824	961	1,098
Maximum Loads (t)	84.0	98.0	112.0

13. Rated loads listed apply only to the machine as originally manufactured and designed by KOBELCO CONSTRUCTION MACHINERY CO., LTD. Modifications to this machine or use of equipment other than that specified can reduce operating capacity.

Operation of this equipment in excess of rated loads or disregard of instruction voids the warranty.



# LUFFING JIB SUPPLEMENTAL DATA

1. Ratings according to EN13000.
2. Operating radius is the horizontal distance from centerline of rotation to a vertical line through the center of gravity of the load.
3. Deduct weight of hook block(s), slings and all other load handling accessories from luffing jib ratings shown.
4. Ratings shown are based on freely suspended loads and make no allowance for such factors as wind effect on lifted load, ground conditions, out-of-level, operating speeds or any other condition that could be detrimental to the safe operation of this equipment. the operator, therefore, has the responsibility to judge the existing conditions and reduce lifted loads and operating speeds accordingly.
5. Ratings are for operation on a firm and level surface, up to 1% gradient.
6. At radii and boom lengths where no ratings are shown on chart, operation is not intended nor approved.
7. Boom and jib inserts and guy lines must be arranged as shown in the "OPERATOR'S MANUAL".
8. Boom hoist reeving is 30 part line. HL/SHL boom hoist reeving is 18 part line. Jib hoist reeving is 18 part line.
9. Boom and jib backstops are required for all boom lengths.
10. The boom should be erected over the front of the crawlers, not laterally.

11. Ratings inside of boxes  are limited by strength of materials.
12. When erecting and lowering the boom length of 54m or over, the blocks for erection must be placed at the end of the crawlers. (for STD MAST)
13. The minimum rated load is 4.0 ton.

#### 14. (Luffing Jib Rating Loads)

The total load that can be lifted is the value for weight of hook block, slings, and all other load handling accessories deducted from luffing jib ratings shown.

#### 15. (Luffing Jib Lifting with Auxiliary Sheave Frame)

The total load that can be lifted is weight of hook block, slings, and all other load handling accessories deducted from luffing jib ratings shown.

#### 16. (Auxiliary Sheave Lifting)

The total load that can be lifted over an auxiliary sheave is weight of hook block, slings, and all other load handling accessories deducted from luffing jib ratings shown, but it should not exceed 14.0 ton in case of one reeve.

It should not exceed 28.0 ton in case of two reeves.

Boom and jib combinations for auxiliary sheave mounting are all boom and jib combinations.

Auxiliary sheave ratings at any radius from center of rotation are the same as luffing ratings shown in table for jib when operated at the same radius.

But maximum angle is the same jib maximum angle.

#### 17. Luffing boom and jib combinations.

		Jib Length										
		24 m (79 ft)	30 m (98 ft)	36 m (118 ft)	42 m (138 ft)	48 m (157 ft)	54 m (177 ft)	60 m (197 ft)	66 m (217 ft)	72 m (236 ft)	78 m (256 ft)	84 m (276 ft)
Boom Length	30 m (98 ft)	○*	○*	○*	○*	○*	○*	○*	○*	○*	×	×
	36 m (118 ft)	○	○	○	○	○	○	○	○	○	○**	○**
	42 m (138 ft)	○	○	○	○	○	○	○	○	○	○**	○**
	48 m (157 ft)	○	○	○	○	○	○	○	○	○	○**	○**
	54 m (177 ft)	○	○	○	○	○	○	○	○	○	○**	○**
	60 m (197 ft)	○	○	○	○	○	○	○	○	○	○**	○**
	66 m (217 ft)	○***	○***	○***	○***	○***	○***	○***	○***	○***	○**	○**
	72 m (236 ft)	○**	○**	○**	○**	○**	○**	○**	○**	○**	○**	○**
	78 m (256 ft)	×	○**	○**	○**	○**	○**	○**	○**	○**	○**	○**
84 m (276 ft)	×	○**	○**	○**	○**	○**	○**	○**	○**	○**	○**	

- × : All luffing jib combinations which is not allowed.
- : All luffing jib combinations which is allowed.
- \* : STD luffing jib combinations which is allowed.
- \*\* : SHL luffing jib combinations which is allowed.
- \*\*\* : HL and SHL luffing jib combinations which is allowed.

18. Maximum hoist load for number of reeving parts of line for hoist rope.

**For Jib Hook (Single Drum)**

No. of Parts of Line	1	2	3	4	5
Maximum Loads (kN)	137	275	412	549	686
Maximum Loads (t)	14.0	28.0	42.0	56.0	70.0

No. of Parts of Line	6	7	8	9	10
Maximum Loads (kN)	824	961	1,098	1,236	1,373
Maximum Loads (t)	84.0	98.0	112.0	126.0	140.0

No. of Parts of Line	11	12	13	14	15
Maximum Loads (kN)	1,491	1,608	1,706	1,804	1,883
Maximum Loads (t)	152.0	164.0	174.0	184.0	192.0

No. of Parts of Line	16
Maximum Loads (kN)	1,961
Maximum Loads (t)	200.0

**For Jib Hook (Double Drum)**

No. of Parts of Line	8	12	16
Maximum Loads (kN)	1,098	1,608	1,961
Maximum Loads (t)	112.0	164.0	200.0

**For Auxiliary Sheave**

No. of Parts of Line	1	2
Maximum Loads (kN)	137	275
Maximum Loads (t)	14.0	28.0

Weight of hook block					
Hook block	200 ton	120 ton	70 ton	40 ton	14ton Ball hook
Weight (t)	7.1	4.5	3.1	2.0	0.9

19. Maximum number of reeving parts of line for hoist rope.

**STD Luffing Jib (For Double Drum)**

		Jib Length (m)								
		24	30	36	42	48	54	60	66	72
Boom Length (m)	30	16	12	12	8	8	8	8	8	8
	36	16	12	12	8	8	8	8	8	8
	42	16	12	12	8	8	8	8	8	8
	48	12	12	12	8	8	8	8	8	8
	54	12	12	12	8	8	8	8	8	8
	60	12	12	8	8	8	8	8	8	8

**HL Luffing Jib (For Double Drum)**

		Jib Length (m)								
		24	30	36	42	48	54	60	66	72
Boom Length (m)	36	16	16	12	12	12	8	8	8	8
	42	16	16	12	12	12	8	8	8	8
	48	16	16	12	12	8	8	8	8	8
	54	16	12	12	12	8	8	8	8	8
	60	12	12	12	12	8	8	8	8	8
	66	12	12	12	8	8	8	8	8	8

**SHL Luffing Jib (For Double Drum)**

		Jib Length (m)										
		24	30	36	42	48	54	60	66	72	78	84
Boom Length (m)	36	16	16	12	12	12	12	8	8	8	8	8
	42	16	16	12	12	12	8	8	8	8	8	8
	48	16	16	12	12	12	8	8	8	8	8	8
	54	16	16	12	12	12	8	8	8	8	8	8
	60	16	12	12	12	8	8	8	8	8	8	8
	66	12	12	12	8	8	8	8	8	8	8	8
	72	12	12	12	8	8	8	8	8	8	8	8
	78	×	12	8	8	8	8	8	8	8	8	8
	84	×	8	8	8	8	8	8	8	8	8	×

× : Combinations which is not allowed.

**STD Luffing Jib (For Single Drum)**

		Jib Length (m)								
		24	30	36	42	48	54	60	66	72
Boom Length (m)	30	13	11	10	8	8	7	7	6	5
	36	11	10	9	8	8	7	7	6	5
	42	10	9	9	8	7	7	6	6	5
	48	9	9	8	7	7	6	6	6	5
	54	9	8	7	7	6	6	6	5	5
	60	8	7	7	6	6	6	5	5	4

**HL Luffing Jib (For Single Drum)**

		Jib Length (m)								
		24	30	36	42	48	54	60	66	72
Boom Length (m)	36	11	10	9	9	8	7	7	6	5
	42	10	9	9	8	7	7	6	6	5
	48	9	9	8	7	7	6	6	6	5
	54	9	8	7	7	6	6	6	5	5
	60	8	7	7	6	6	6	5	5	5
	66	7	7	6	6	6	5	5	5	4

**SHL Luffing Jib (For Single Drum)**

		Jib Length (m)										
		24	30	36	42	48	54	60	66	72	78	84
Boom Length (m)	36	11	10	9	9	8	7	7	6	6	4	4
	42	10	9	9	8	7	7	6	6	5	4	4
	48	9	9	8	7	7	6	6	6	5	4	4
	54	9	8	7	7	6	6	6	5	5	4	4
	60	8	7	7	6	6	6	5	5	5	4	4
	66	7	7	6	6	6	5	5	5	4	4	3
	72	7	6	6	5	5	5	5	4	4	4	3
	78	×	6	5	5	5	5	4	4	4	3	3
	84	×	5	5	5	5	4	4	4	3	3	3

× : Combinations which is not allowed.

20. Lifting capacities listed apply only to the machine as originally manufactured and designed by KOBELCO CONSTRUCTION MACHINERY CO., LTD. Modifications to this machine or use of equipment other than that specified can reduce operating capacity.

Operation of this equipment in excess of rated loads or disregard of instruction voids the warranty.



# LUFFING JIB SUPPLEMENTAL DATA

## 21. Hook block and number of reeving parts of line restriction

- (1) The self-weight of luffing jib point hook block must be heavier than or equal to the table below.
- (2) Total number of reeving parts of line on luffing jib point hook block must be larger than or equal to the table below.

**Danger!**

Follow the both (1) and (2) above at a same time for the luffing jib operation.

Otherwise luffing jib may tip over the backwards due to lack of weight on front side of boom.

Failure to observe this precaution may lead to the jib tipping backwards and resulted to machine collapsing.

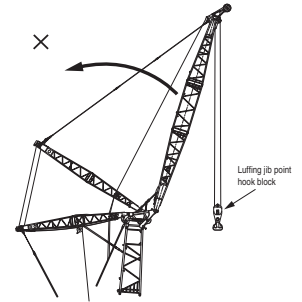

SL6000S minimum hook block self-weight and minimum number of reeving parts of line on hook block

Boom Length	Jib Length	24 m	30 m	36 m	42 m	48 m	54 m	60 m	66 m	72 m	78 m	84 m
		(79 ft)	(98 ft)	(118 ft)	(138 ft)	(157 ft)	(177 ft)	(197 ft)	(217 ft)	(236 ft)	(256 ft)	(276 ft)
30 m (98 ft)	Hook Block Self-Weight (kg)	7,050	4,500	3,100	2,000	2,000	2,000	2,000	2,000	2,000	2,000	2,000
	No. of Part Line	13	6	4	2	2	2	2	2	2	2	2
36 m (118 ft)	Hook Block Self-Weight (kg)	7,050	4,500	3,100	2,000	2,000	2,000	2,000	2,000	2,000	2,000	2,000
	No. of Part Line	11	6	4	2	2	2	2	2	2	2	2
42 m (138 ft)	Hook Block Self-Weight (kg)	7,050	7,050	3,100	2,000	2,000	2,000	2,000	2,000	2,000	2,000	2,000
	No. of Part Line	10	9	4	2	2	2	2	2	2	2	2
48 m (157 ft)	Hook Block Self-Weight (kg)	7,050	7,050	3,100	2,000	2,000	2,000	2,000	2,000	2,000	2,000	2,000
	No. of Part Line	9	9	4	2	2	2	2	2	2	2	2
54 m (177 ft)	Hook Block Self-Weight (kg)	7,050	7,050	4,500	3,100	2,000	2,000	2,000	2,000	2,000	2,000	2,000
	No. of Part Line	9	8	6	2	2	2	2	2	2	2	2
60 m (197 ft)	Hook Block Self-Weight (kg)	7,050	7,050	7,050	3,100	2,000	2,000	2,000	2,000	2,000	2,000	2,000
	No. of Part Line	8	7	7	3	2	2	2	2	2	2	2
66 m (217 ft)	Hook Block Self-Weight (kg)	7,050	7,050	7,050	4,500	3,100	2,000	2,000	2,000	2,000	2,000	2,000
	No. of Part Line	7	7	6	2	2	2	2	2	2	2	2
72 m (236 ft)	Hook Block Self-Weight (kg)	7,050	7,050	7,050	4,500	3,100	2,000	2,000	2,000	2,000	2,000	2,000
	No. of Part Line	7	6	6	2	2	2	2	2	2	2	2
78 m (256 ft)	Hook Block Self-Weight (kg)		7,050	7,050	4,500	3,100	2,000	2,000	2,000	2,000	2,000	2,000
	No. of Part Line		6	5	2	2	2	2	2	2	2	2
84 m (276 ft)	Hook Block Self-Weight (kg)		7,050	7,050	4,500	3,100	2,000	2,000	2,000	2,000	2,000	2,000
	No. of Part Line		5	5	3	2	2	2	2	2	2	2

Weight of KOBELCO genuine hook block.

200 t hook block	7,050 kg	70 t hook block	3,100 kg
120 t hook block	4,500 kg	40 t hook block	2,000 kg



Lined writing area with horizontal lines for text entry.





## LIFTING CAPACITIES

### Heavy Duty Crane Boom Lifting Capacities

Unit: ton

Counterweight: 200.0 ton, Carbody weight: 50.0 ton

Working Radius (m)	Boom Length (m)	Lifting Capacity (ton)										Working Radius (m)	
		24.0	30.0	36.0	42.0	48.0	54.0	60.0	66.0	72.0	78.0		84.0
6.0	6.7 m/450.0												6.0
7.0	447.1	7.5 m/417.3											7.0
8.0	391.2	391.2	8.3 m/370.0										8.0
9.0	347.7	347.7	347.7	9.2 m/333.8									9.0
10.0	307.0	307.0	306.0	305.0	10.0 m/291.6	10.9 m/254.8	11.7 m/224.8						10.0
12.0	246.0	246.8	246.0	245.0	240.4	230.0	220.4	12.5 m/198.6	13.4 m/176.4				12.0
14.0	201.5	202.5	202.5	201.7	200.5	193.6	186.2	179.1	172.3	14.2 m/157.1	15.0 m/139.7		14.0
16.0	169.5	170.7	170.7	169.9	168.7	166.5	160.5	154.7	149.2	143.7	136.8		16.0
18.0	144.4	144.2	144.3	144.0	143.1	142.9	140.5	135.5	130.9	126.2	121.8		18.0
20.0	124.0	123.8	123.9	123.4	122.6	122.3	121.2	120.1	116.1	112.0	108.1		20.0
22.0	22.0 m/108.3	108.0	108.0	107.5	106.6	106.3	105.2	104.9	103.8	100.2	96.8		22.0
24.0		95.5	95.4	94.9	93.9	93.6	92.5	92.1	91.1	90.0	87.1		24.0
26.0		85.3	85.1	84.5	83.6	83.2	82.1	81.7	80.7	79.5	78.9		26.0
28.0		76.8	76.6	76.0	75.0	74.6	73.4	73.0	72.0	70.8	70.6		28.0
30.0		28.6 m/74.6	69.4	68.7	67.7	67.3	66.1	65.7	64.6	63.5	63.2		30.0
32.0			63.3	62.6	61.5	61.0	59.9	59.4	58.4	57.2	56.9		32.0
34.0			33.8 m/58.5	57.3	56.2	55.7	54.5	54.0	52.9	51.7	51.4		34.0
36.0				52.6	51.5	51.0	49.8	49.2	48.2	47.0	46.6		36.0
38.0				48.6	47.5	46.9	45.7	45.1	44.0	42.8	42.4		38.0
40.0				39.0 m/46.8	43.9	43.2	42.0	41.4	40.3	39.1	38.7		40.0
44.0					37.8	37.1	35.8	35.1	34.1	32.8	32.4		44.0
48.0					44.2 m/37.6	32.1	30.8	30.1	29.0	27.7	27.2		48.0
52.0						49.4 m/30.6	26.7	25.9	24.8	23.5	23.0		52.0
56.0							54.6 m/24.5	22.4	21.3	19.6	18.8		56.0
60.0								59.8 m/19.3	18.0	16.1	60.0 m/15.2		60.0
64.0									15.0	64.0 m/13.1			64.0
68.0									65.0 m/14.4				68.0
Reeves	36	36	28	24	24	20	20	16	16	12	12		Reeves

Note : Ratings according to EN13000.

Ratings shown in   are determined by the strength of the boom or other structural components.

Lifting capacities may vary depending on hook used or with / without auxiliary sheave.

Please refer rated chart in operator's cabin.

### Heavy Fixed Jib (Type A) Lifting Capacities

Unit: ton

Counterweight: 200.0 ton, Carbody weight: 50.0 ton

Working Radius (m)	Jib Length (m) 18.0			Working Radius (m)
	66.0	72.0	78.0	
20.0	105.0	100.0	95.0	20.0
22.0	98.1	94.7	91.2	22.0
24.0	88.1	85.0	81.9	24.0
26.0	79.6	76.7	73.8	26.0
28.0	71.1	69.5	66.8	28.0
30.0	63.6	62.3	60.6	30.0
34.0	51.5	50.1	48.6	34.0
38.0	42.0	40.6	39.1	38.0
42.0	34.4	33.0	31.5	42.0
46.0	28.2	26.8	25.3	46.0
50.0	23.1	21.7	20.1	50.0
54.0	18.7	17.3	15.7	54.0
58.0	14.9	13.5	11.9	58.0
62.0	11.6	10.3	8.7	62.0
Reeves	8	8	8	Reeves

Note : Ratings according to EN13000 .

Ratings shown in   are determined by the strength of the boom or other structural components.

Lifting capacities may vary depending on hook used or with / without auxiliary sheave.

Please refer rated chart in operator's cabin.

### Long Boom Lifting Capacities

Unit: ton

Counterweight: 200.0 ton, Carbody weight: 50.0 ton

Working Radius (m)	Boom Length (m)	Lifting Capacity (ton)				Working Radius (m)
		90.0	96.0	102.0	108.0	
14.0	15.0 m/98.0	15.8 m/84.0			14.0	
16.0	98.0	84.0	16.6 m/70.0	17.5 m/70.0	16.0	
18.0	98.0	84.0	70.0	70.0	18.0	
20.0	96.5	84.0	70.0	70.0	20.0	
22.0	87.7	84.0	70.0	70.0	22.0	
24.0	80.4	80.4	70.0	70.0	24.0	
26.0	74.2	74.2	70.0	70.0	26.0	
28.0	68.9	68.9	68.0	62.5	28.0	
30.0	62.6	64.3	62.3	55.9	30.0	
32.0	56.7	59.7	57.2	50.3	32.0	
34.0	51.5	54.9	52.7	45.3	34.0	
36.0	46.9	50.1	48.6	41.0	36.0	
38.0	42.8	45.9	45.0	37.1	38.0	
40.0	39.1	42.1	41.3	33.6	40.0	
44.0	32.8	35.7	34.6	27.6	44.0	
48.0	27.6	30.5	29.1	22.7	48.0	
52.0	23.1	26.0	24.5	18.6	52.0	
56.0	19.3	22.0	20.5	15.0	56.0	
60.0	16.0	18.5	17.1	60.0 m/11.9	60.0	
64.0	13.1	15.5	14.1		64.0	
68.0	10.4	12.9	11.4		68.0	
72.0	72.0 m/8.1	70.0 m/11.7	70.0 m/10.2		72.0	
Reeves	7	6	5	5	Reeves	

Note : Ratings according to EN13000 .

Ratings shown in   are determined by the strength of the boom or other structural components.

Lifting capacities may vary depending on hook used or with / without auxiliary sheave.

Please refer rated chart in operator's cabin.



# Luffing Boom Lifting Capacities

Unit: ton

Counterweight: 200.0 ton, Carbody weight: 50.0 ton

Working Radius (m) \ Boom Length (m)	30.0	36.0	42.0	48.0	54.0	60.0	66.0	72.0	78.0	84.0	Working Radius (m) \ Boom Length (m)
7.0	7.7 m/300.0										7.0
8.0	300.0	8.5 m/300.0									8.0
9.0	300.0	300.0	9.3 m/300.0								9.0
10.0	300.0	300.0	300.0	10.2 m/280.0	11.0 m/248.5	11.8 m/220.0					10.0
12.0	244.1	243.6	242.7	238.1	227.8	218.2	12.7 m/196.6	13.5 m/164.0			12.0
14.0	200.6	200.0	199.2	198.3	191.3	184.0	176.8	164.0	14.3 m/155.5	15.2 m/138.6	14.0
16.0	168.9	168.7	167.8	166.9	164.2	158.2	152.4	146.9	141.5	136.3	16.0
18.0	143.1	142.7	142.0	141.8	141.0	138.1	133.2	128.6	124.0	119.6	18.0
20.0	122.7	122.3	121.5	121.2	120.4	120.0	117.8	113.8	109.7	105.9	20.0
22.0	106.9	106.4	105.6	105.2	104.4	104.0	103.0	101.5	97.9	94.5	22.0
24.0	94.3	93.8	93.0	92.5	91.7	91.2	90.2	90.0	88.0	84.8	24.0
26.0	84.0	83.5	82.6	82.2	81.3	80.8	79.8	79.5	78.5	76.6	26.0
28.0	75.4	74.9	74.1	73.5	72.6	72.1	71.1	70.8	69.7	68.7	28.0
30.0	28.7 m/72.8	67.7	66.8	66.3	65.4	64.8	63.7	63.5	62.4	61.3	30.0
32.0		61.6	60.7	60.1	59.1	58.6	57.5	57.2	56.1	55.0	32.0
34.0		33.9 m/56.6	55.3	54.7	53.7	53.2	52.1	51.7	50.6	49.5	34.0
36.0			50.7	50.0	49.1	48.4	47.3	47.0	45.8	44.7	36.0
38.0			46.7	45.9	44.9	44.3	43.2	42.8	41.6	40.5	38.0
40.0			39.1 m/44.7	42.3	41.3	40.6	39.5	39.1	37.9	36.8	40.0
44.0				36.2	35.1	34.4	33.2	32.8	31.6	30.4	44.0
48.0				44.3 m/35.8	30.2	29.3	28.1	27.6	26.5	25.3	48.0
52.0					49.5 m/28.6	25.2	24.0	23.4	22.0	20.4	52.0
56.0						54.7 m/22.4	20.3	19.4	17.8	16.1	56.0
60.0							59.9 m/16.5	15.8	14.2	12.5	60.0
64.0								12.5	11.1	62.0 m/11.0	64.0
68.0								65.1 m/11.7	66.0 m/9.8		68.0
Reeves	24	24	24	20	20	16	16	12	12	12	Reeves

Note :

Ratings according to EN13000.

Ratings shown in   are determined by the strength of the boom or other structural components.

This is rated for double drum.

Lifting capacities may vary depending on hook used or with / without auxiliary sheave.

Please refer rated chart in operator's cabin.

Ratings enclosed in gray color box in the table require double-drum specifications.



## LIFTING CAPACITIES

### Luffing Jib Lifting Capacity

Unit: ton

Counterweight: 200.0 ton, Carbody weight: 50.0 ton

30.0 m Boom Length	30.0																										30.0	
	24.0			30.0			36.0			42.0			48.0			54.0			60.0			66.0			72.0			
	86°	76°	66°	86°	76°	66°	86°	76°	66°	86°	76°	66°	86°	76°	66°	86°	76°	66°	86°	76°	66°	86°	76°	66°	86°	76°		66°
14.0	195.1																											14.0
15.0	182.0																											15.0
16.0	170.7			164.0																								16.0
17.0	160.6			160.6																								17.0
18.0	151.7			151.7			148.2																					18.0
20.0	134.3			134.3			133.2			112.0																		20.0
22.0	119.1			119.1			118.4			112.0																		22.0
24.0	106.3	99.6		106.3			105.6			105.6			104.3			100.2												24.0
26.0	95.8	89.8		95.8	89.5		95.1			95.1			94.4			93.8			89.3									26.0
28.0	85.8	81.6		87.1	81.4		86.4			86.4			85.7			85.1			84.3			79.9						28.0
30.0		74.7		79.7	74.4		79.1	73.6		79.1			78.4			77.7			77.0			76.2				64.1		30.0
34.0		63.6	59.4	66.6	63.4		67.4	62.6		67.3	62.5		66.6			66.0			65.3			64.5				58.7		34.0
38.0			51.5		55.0	51.2	58.5	54.2		58.4	54.1		57.7	53.2		57.1	52.5		56.3			55.5				51.8		38.0
42.0					44.9		47.7	44.1		51.3	47.5		50.6	46.7		50.0	46.0		49.3	45.1		48.5				47.0		42.0
46.0							42.4	39.1		45.6	42.1		38.8	44.9	41.3		44.3	40.6		43.6	39.8		42.8	38.6		42.1	37.6	46.0
50.0								35.1		37.7	34.7		40.3	37.0	33.5	39.6	36.3	32.5		38.9	35.4		38.1	34.2		37.4	33.1	50.0
54.0										31.3			37.0	33.3	30.0	35.7	32.6	29.0	35.0	31.6	27.7	34.2	30.4			33.5	29.3	54.0
58.0													30.2	27.1	32.5	29.5	26.0	31.7	28.4	24.8	30.9	27.2	23.5	30.0	26.1			58.0
62.0														24.5		26.9	23.5	28.9	25.6	22.2	28.0	24.4	20.9	27.0	23.4	19.8		62.0
66.0																21.3		23.3	20.0	25.5	22.0	18.7	24.4	21.0	17.6			66.0
70.0																				18.1	23.3	20.0	16.8	21.8	18.9	15.7		70.0
74.0																				16.5		18.2	15.2	19.1	17.1	14.1		74.0
78.0																							13.7		15.5	12.6		78.0
82.0																										11.3		82.0
86.0																										10.2		86.0
Reeves		16			12			12			8			8			8			8			8			8		Reeves

36.0 m Boom Length	36.0																										36.0		
	24.0			30.0			36.0			42.0			48.0			54.0			60.0			66.0			72.0				
	86°	76°	66°	86°	76°	66°	86°	76°	66°	86°	76°	66°	86°	76°	66°	86°	76°	66°	86°	76°	66°	86°	76°	66°	86°	76°		66°	
15.0	182.0																											15.0	
16.0	170.7																											16.0	
17.0	160.6			156.6																								17.0	
18.0	151.2			148.5			143.1																					18.0	
20.0	133.1			133.2			129.4			112.0																		20.0	
22.0	118.5			118.5			117.5			112.0			109.6															22.0	
24.0	105.7			105.8			105.1			104.2			102.1			97.1												24.0	
26.0	95.3	87.9		95.3			94.7			94.7			94.0			91.3			86.6									26.0	
28.0	86.6	79.8		86.6	79.6		86.0			86.0			85.3			84.6			82.2			77.4						28.0	
30.0	78.4	73.0		79.3	72.8		78.7			78.7			78.0			77.3			76.4			74.1				64.7		30.0	
34.0		62.2		67.6	62.0		67.0	61.1		67.0	61.0		66.3			65.6			64.9			64.1				57.9		34.0	
38.0			49.3		53.7	48.9	58.1	52.9		58.1	52.8		57.3	51.9		56.7			56.0			55.2				52.2		38.0	
42.0			43.3		47.2	42.9	46.4	41.6		51.0	46.3		50.3	45.5		49.7	44.7		48.9	43.5		48.2				47.3		42.0	
46.0					38.1		41.2	36.8	45.3	41.1	36.5	44.6	40.2		44.0	39.5		43.3	38.2		42.5	37.0				41.8		46.0	
50.0							32.9	36.8	32.5	40.0	35.9	31.2	39.4	35.1		38.6	33.9		38.6	33.9		37.8	32.6			37.1	31.5	50.0	
54.0								29.6			29.1		32.4	27.8	35.5	31.4	26.7	34.7	30.2		33.9	28.9				33.0	27.9	54.0	
58.0											26.3		29.3	25.0	32.2	28.3	23.9	31.4	27.0	22.6	30.5	25.8				29.5	24.7	58.0	
62.0													22.6			25.6	21.5	28.6	24.4	20.2	27.6	23.1	18.9	26.5	22.1			62.0	
66.0																19.4		22.0	18.1	25.0	20.8	16.8	24.0	19.7	15.7			66.0	
70.0																	17.6		20.1	16.3	22.8	18.8	15.0	21.3	17.7	13.8		70.0	
74.0																				14.7		17.0	13.4	18.6	15.9	12.3		74.0	
78.0																							12.0		14.4	10.9		78.0	
82.0																								10.8		12.0	9.6		82.0
86.0																										8.6		86.0	
Reeves		16			12			12			8			8			8			8			8			8		Reeves	

Note : Ratings according to EN13000.  
 Ratings shown in   .  
 Lifting capacities may vary depending on hook used or with / without auxiliary sheave.  
 Please refer rated chart in operator's cabin.  
 Ratings enclosed in gray color box in the table require double-drum specifications.



# Luffing Jib Lifting Capacity

Unit: ton

Counterweight: 200.0 ton, Carbody weight: 50.0 ton

42.0 m Boom Length	42.0																											42.0 m Boom Length		
	24.0			30.0			36.0			42.0			48.0			54.0			60.0			66.0			72.0					
	86°	76°	66°	86°	76°	66°	86°	76°	66°	86°	76°	66°	86°	76°	66°	86°	76°	66°	86°	76°	66°	86°	76°	66°	86°	76°	66°			
15.4	172.7																											15.4		
16.0	166.0																											16.0		
17.0	156.2			151.0																								17.0		
18.0	148.2			143.4																								18.0		
20.0	131.6			129.0			125.2																					20.0		
22.0	117.3			117.2			113.8			109.3			106.0															22.0		
24.0	105.2			105.2			104.1			101.9			99.0			94.0												24.0		
26.0	94.7			94.8			94.1			94.0			91.3			88.6			83.8									26.0		
28.0	86.1	77.5		86.2			85.5			85.6			84.6			82.1			79.8			74.9						28.0		
30.0	78.7	71.2		78.9	70.9		78.2			78.3			77.6			76.4			74.2			72.0			65.4			30.0		
34.0		60.6		67.2	60.4		66.5	59.4			66.6			65.9			65.2			64.5			62.8			58.4		34.0		
38.0		52.4	46.0		52.3		57.7	51.5			57.7	51.4			57.0	50.1			56.3			55.6			54.8		52.6	38.0		
42.0			40.3		45.9	39.8		50.7	45.1			50.7	45.0			50.0	43.8			49.3	42.7			48.6		47.8	47.0	42.0		
46.0					35.2		40.0	33.9			45.0	39.9			44.3	38.7			43.7	37.6			42.9	36.3		42.1	35.0	46.0		
50.0					31.4			30.2			35.6	29.9			39.7	34.4			39.0	33.4			38.3	32.1		37.4	30.8	50.0		
54.0								27.0			32.0	26.7				30.8	25.3			35.2	29.8			34.4	28.5		33.4	27.3	54.0	
58.0											24.0	24.0				27.8	22.7			31.9	26.7			21.5	31.1		29.9	24.2	58.0	
62.0												21.6					20.3			24.1	19.2			28.2	22.9		17.9	27.0	62.0	
66.0													18.4					18.4			21.9	17.3			20.7	15.9	24.5	19.4	66.0	
70.0																					15.5				18.7	14.2	22.3	17.4	70.0	
74.0																						14.1				12.7		15.7	11.4	74.0
78.0																										11.4		14.3	10.1	78.0
82.0																												8.9	11.8	82.0
86.0																													6.8	86.0
90.0																													5.9	90.0
Reeves		16			12			12			8			8			8			8			8			8		8		Reeves

48.0 m Boom Length	48.0																											48.0 m Boom Length				
	24.0			30.0			36.0			42.0			48.0			54.0			60.0			66.0			72.0							
	86°	76°	66°	86°	76°	66°	86°	76°	66°	86°	76°	66°	86°	76°	66°	86°	76°	66°	86°	76°	66°	86°	76°	66°	86°	76°	66°					
16.2	158.0																												16.2			
17.0	151.2			145.4																									17.0			
18.0	143.0			138.3																									18.0			
20.0	128.8			124.7			121.0																						20.0			
22.0	115.8			113.4			110.1			105.7																			22.0			
24.0	104.2			103.9			101.8			98.8			93.8			90.8													24.0			
26.0	94.2			94.3			93.6			91.2			88.6			85.9			81.1										26.0			
28.0	85.5	74.4		85.7			85.0			84.5			82.1			79.6			77.4			72.4							28.0			
30.0	78.2	68.3		78.4			77.7			77.8			76.5			74.1			72.0			69.8					65.0		30.0			
34.0		58.3		66.7	58.1		66.1	56.8			66.2			65.5			64.8			63.0			60.9				58.9		34.0			
38.0		50.6			50.4		57.2	49.1			57.3	49.1			56.6			56.0			55.2			53.8			52.1		38.0			
42.0			37.0		44.2		50.3	43.0			50.3	43.0			49.6	41.7			49.0	40.6			48.2			47.2		46.1	42.0			
46.0			32.6			32.2		38.1			44.7	38.0			44.0	36.7			43.4	35.6			42.6	34.3			41.4		40.4	46.0		
50.0						28.6		34.0	27.3			33.8	27.1			39.4	32.6			38.7	31.5			37.8	30.2			36.7	28.9	50.0		
54.0								24.3			30.3	24.1			35.5	29.1	22.7			34.9	28.1			33.8	26.8			32.7	25.5	54.0		
58.0								21.9				21.5				26.2	20.2			31.6	25.1			30.5	23.9			29.3	22.6	58.0		
62.0											19.3					23.7	18.0				25.1	19.0			30.5	23.9			22.6	21.5	62.0	
66.0												16.1					16.1			20.5	15.0			19.2	13.7			23.9	17.9	66.0		
70.0													14.5								13.4				17.3	12.1			20.6	16.0	70.0	
74.0																						12.0				15.7	10.7			14.4	9.3	74.0
78.0																											9.4		13.0	8.1	78.0	
82.0																												8.4		7.0	10.5	82.0
Reeves		12			12			12			8			8			8			8			8			8		8		8		Reeves

Note : Ratings according to EN13000.

Ratings shown in  .

Lifting capacities may vary depending on hook used or with / without auxiliary sheave.

Please refer rated chart in operator's cabin.

Ratings enclosed in gray color box in the table require double-drum specifications.



## BOOM AND JIB ARRANGEMENTS

### Luffing Jib Lifting Capacity

Unit: ton

Counterweight: 200.0 ton, Carbody weight: 50.0 ton

54.0 m Boom Length	54.0																								Reeves				
	24.0			30.0			36.0			42.0			48.0			54.0			60.0			66.0				72.0			Reeves
	86°	76°	66°	86°	76°	66°	86°	76°	66°	86°	76°	66°	86°	76°	66°	86°	76°	66°	86°	76°	66°	86°	76°	66°					
17.0	145.7																								17.0				
18.0	137.8			132.5																						18.0			
20.0	124.3			120.4			115.8																			20.0			
22.0	113.2			109.6			106.4			102.1																22.0			
24.0	102.8			101.5			98.6			95.6				90.6												24.0			
26.0	93.2			93.5			91.0			88.3				85.8			80.8									26.0			
28.0	84.9			85.1			84.3			82.0				79.6			77.1				72.3			69.9		28.0			
30.0	77.6	65.3		77.8			77.1			76.4				74.1			71.8				69.7			67.5		30.0			
34.0		55.6		66.2	55.5		65.5			65.7				65.0			62.9				61.0			59.0		34.0			
38.0		48.2			48.0		56.7	46.7		56.9	46.8			56.2			55.5				54.0			52.1		38.0			
42.0			33.6		42.1		49.8	40.8		49.9	40.8			49.2	39.5		48.6				47.5			46.3		42.0			
46.0			29.5		37.2	29.2		36.0		44.3	36.0			43.6	34.7		43.0	33.6			41.8	31.9		40.7		46.0			
50.0						25.8		32.1	24.4		32.0			39.0	30.7		38.3	29.7			37.1	28.3		36.0	26.5	50.0			
54.0						22.9			21.6		28.6	21.4		35.1	27.4		34.3	26.3			33.2	25.0		32.0	23.7	54.0			
58.0									19.3		25.8	19.0			24.5	17.6		31.0	23.5		29.8	22.2		28.6	20.9	58.0			
62.0											17.0				22.1	15.6		21.1	14.4		27.0	19.8		25.8	18.5	62.0			
66.0											15.2					13.8		19.0	12.7		23.2	17.7	11.3	23.3	16.4	66.0			
70.0																12.3					11.2		15.9	9.8	19.3	14.6	70.0		
74.0																					9.9		14.3	8.5		13.0	74.0		
78.0																					8.8			7.4		11.6	78.0		
82.0																										9.2	82.0		
86.0																										8.2	86.0		
Reeves		12			12			12			8			8			8			8			8			8	Reeves		

60.0 m Boom Length	60.0																								Reeves				
	24.0			30.0			36.0			42.0			48.0			54.0			60.0			66.0				72.0			Reeves
	86°	76°	66°	86°	76°	66°	86°	76°	66°	86°	76°	66°	86°	76°	66°	86°	76°	66°	86°	76°	66°	86°	76°	66°					
17.8	131.2																										17.8		
18.0	132.8			127.5																								18.0	
20.0	120.0			116.2			111.7																					20.0	
22.0	109.3			105.9			103.8			98.5																		22.0	
24.0	101.3			98.2			95.4			92.5				87.5														24.0	
26.0	93.2			90.7			88.1			85.5				83.0			77.9											26.0	
28.0	85.0			84.1			81.9			79.4				77.0			74.6				69.8							28.0	
30.0	77.8			77.2			76.1			74.0				71.8			69.5				67.5				62.4			30.0	
34.0		53.9		65.7	52.6		65.0			65.0				63.0			60.9				59.1			57.1		52.2	34.0		
38.0		46.7			45.4		56.2	44.0		56.5				55.6			54.0				52.3			50.4		48.7	38.0		
42.0		40.8			39.7		49.3	38.4		49.5	38.5			48.7	36.9		47.8				46.6			44.9		43.3	42.0		
46.0			27.2		35.0			33.8		43.9	33.8			43.1	32.5		42.1	30.9			41.0			39.8		38.8	46.0		
50.0			24.0			22.6		30.0			30.0			38.5	28.7		37.5	27.6			36.4	25.8		35.2	24.0	34.2	50.0		
54.0						20.0			18.6		26.7			34.6	25.5		33.6	24.4			32.4	23.1		31.3	21.7	30.3	54.0		
58.0						17.8			16.4		24.0	16.2			22.7		30.3	21.7			29.1	20.4		27.9	19.0	26.9	58.0		
62.0									14.6			14.3			20.4	12.9		19.3	11.8		26.3	18.0		25.1	16.7	24.1	62.0		
66.0												12.7				11.3		17.3	10.2		23.9	16.0		22.6	14.7	21.6	66.0		
70.0															9.9		15.6	8.8			14.3			19.9	13.0	18.5	70.0		
74.0															8.7			7.6			12.8			11.5		15.8	74.0		
78.0																								10.1		12.7	78.0		
82.0																									9.0		7.8	82.0	
86.0																											6.8	86.0	
Reeves		12			12			8			8			8			8			8			8			8	Reeves		

Note : Ratings according to EN13000.

Ratings shown in  .

Lifting capacities may vary depending on hook used or with / without auxiliary sheave.

Please refer rated chart in operator's cabin.

Ratings enclosed in gray color box in the table require double-drum specifications.





## BOOM AND JIB ARRANGEMENTS

### Heavy Duty Crane Boom Arrangements

Boom length m (ft)	Boom arrangement
36 (118)	※
42 (138)	※ 
48 (157)	※
54 (177)	※ 
60 (197)	※
66 (217)	※ 
72 (236)	※
78 (256)	※ 
84 (276)	※

Symbol	Boom Length	Remarks
	9.0 m (29.5 ft)	Boom Base
	8.0 m (26.2 ft)	Taper Boom Insert
	6.0 m (19.7 ft)	Boom Insert
	12.0 m (39.4 ft)	Boom Insert
	1.0 m (3.3 ft)	Heavy Boom Tip

※ indicates the most flexible combination of insert heavy duty booms, which can be modified to form all shorter heavy duty boom arrangements.

### Luffing Boom Arrangements for Crane

Boom length m (ft)	Boom arrangement
36 (118)	※
42 (138)	※ 
48 (157)	※
54 (177)	※ 
60 (197)	※
66 (217)	※ 
72 (236)	※
78 (256)	※ 
84 (276)	※

Symbol	Boom Length	Remarks
	9.0 m (29.5 ft)	Boom Base
	8.0 m (26.2 ft)	Taper Boom Insert
	6.0 m (19.7 ft)	Boom Insert
	12.0 m (39.4 ft)	Boom Insert
	1.0 m (3.3 ft)	Luffing Boom Tip

※ indicates the most flexible combination of insert luffing booms, which can be modified to form all shorter luffing boom arrangements.

# Long Boom Arrangements

Boom length m (ft)	Boom arrangement
90 (295)	
96 (315)	※ 
102 (335)	※   
108 (354)	※ 

Symbol	Boom Length	Remarks
	9.0 m (29.5 ft)	Boom Base
	8.0 m (26.2 ft)	Taper Boom Insert
	6.0 m (19.7 ft)	Boom Insert
	12.0 m (39.4 ft)	Boom Insert
	5.0 m (16.4 ft)	Special Long Boom Insert
	6.0 m (19.7 ft)	Long Boom Insert
	12.0 m (39.4 ft)	Long Boom Insert
	8.0 m (26.2 ft)	Long Boom Tip

※ indicates the most flexible combination of insert long booms, which can be modified to form all shorter long boom arrangements.

# Heavy Fixed Jib Boom Arrangements (Type B1)

Boom length m (ft)	Boom arrangement
66 (217)	※ 
72 (236)	※
78 (256)	※ 

Symbol	Boom Length	Remarks
	9.0 m (29.5 ft)	Boom Base
	8.0 m (26.2 ft)	Taper Boom Insert
	6.0 m (19.7 ft)	Boom Insert
	12.0 m (39.4 ft)	Boom Insert
	1.0 m (3.3 ft)	Boom Tip

↗ mark shows the guy line installing position when the fixed jib is used.

※ indicates the most flexible combination of insert luffing booms, which can be modified to form all shorter luffing boom arrangements.

# Heavy Fixed Jib Arrangements (Type B1)

Jib length m (ft)	Jib arrangement
18 (59)	

Symbol	Jib Length	Remarks
	10.0 m (32.8 ft)	Jib Base
	8.0 m (26.2 ft)	Jib Tip

# HEAVY LIFT

## BOOM AND JIB ARRANGEMENTS

### Luffing Boom Arrangements for Luffing

Boom length m (ft)	Boom arrangement
36 (118)	※
42 (138)	※
48 (157)	※
54 (177)	※
60 (197)	※
66 (217)	※

Symbol	Boom Length	Remarks
	9.0 m (29.5 ft)	Boom Base
	8.0 m (26.2 ft)	Taper Boom Insert
	6.0 m (19.7 ft)	Boom Insert
	12.0 m (39.4 ft)	Boom Insert
	1.0 m (3.3 ft)	Boom Tip

※ indicates the most flexible combination of insert luffing booms, which can be modified to form all shorter luffing boom arrangements.

### Luffing Jib Arrangements

Jib length m (ft)	Jib arrangement
24 (79)	
30 (98)	※
36 (118)	※
42 (138)	※
48 (157)	※
54 (177)	※
60 (197)	※
66 (217)	※
72 (236)	※

Symbol	Jib Length	Remarks
	10.0 m (32.8 ft)	Jib Base
	6.0 m (19.7 ft)	Jib Insert
	12.0 m (39.4 ft)	Jib Insert
	8.0 m (26.2 ft)	Jib Tip

※ indicates the most flexible combination of insert luffing jibs, which can be modified to form all shorter luffing jib arrangements.

## HL MAST

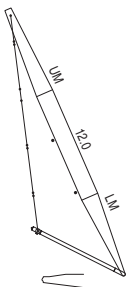

Symbol	Mast Length	Remarks
	9.0 m (29.5 ft)	Mast Base
	12.0 m (39.4 ft)	Mast Insert
	9.0 m (29.5 ft)	Mast Tip

# WORKING RANGES

## Heavy Duty Crane Boom

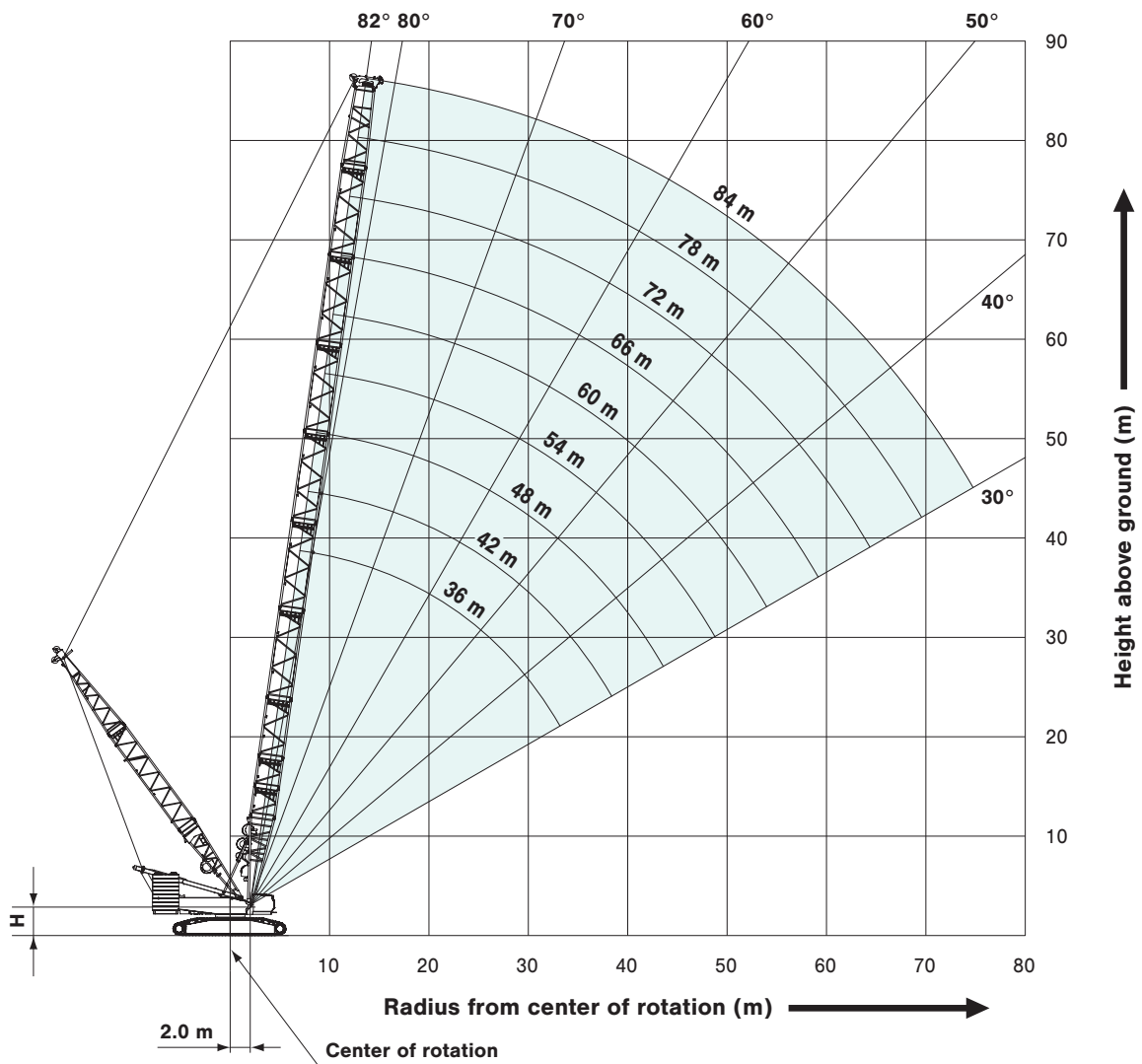

H=2.86 m Without quick connection ring  
H=3.08 m With quick connection ring

## WORKING RANGES

### Luffing Boom

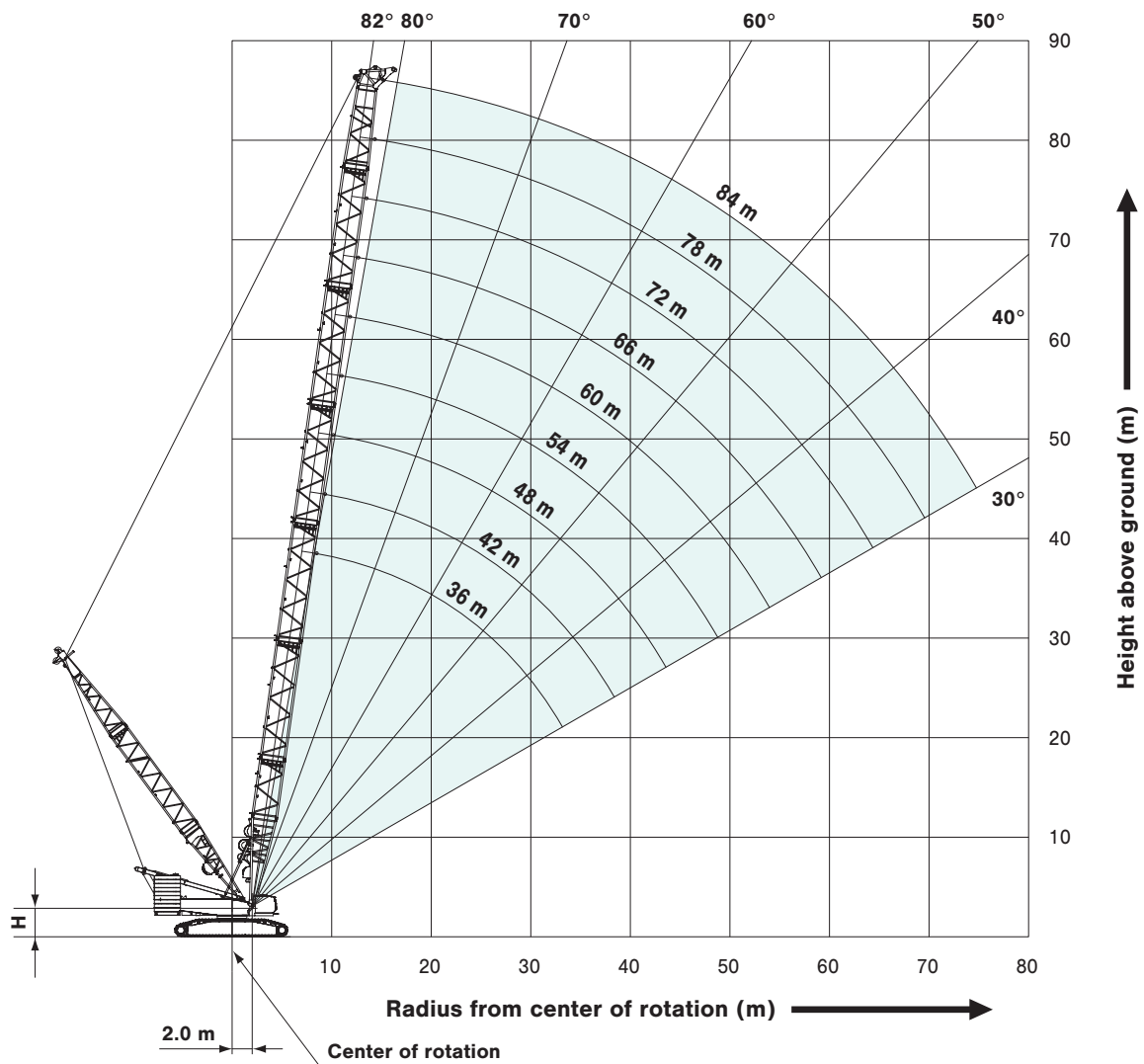

H=2.86 m Without quick connection ring  
H=3.08 m With quick connection ring

# Long Boom

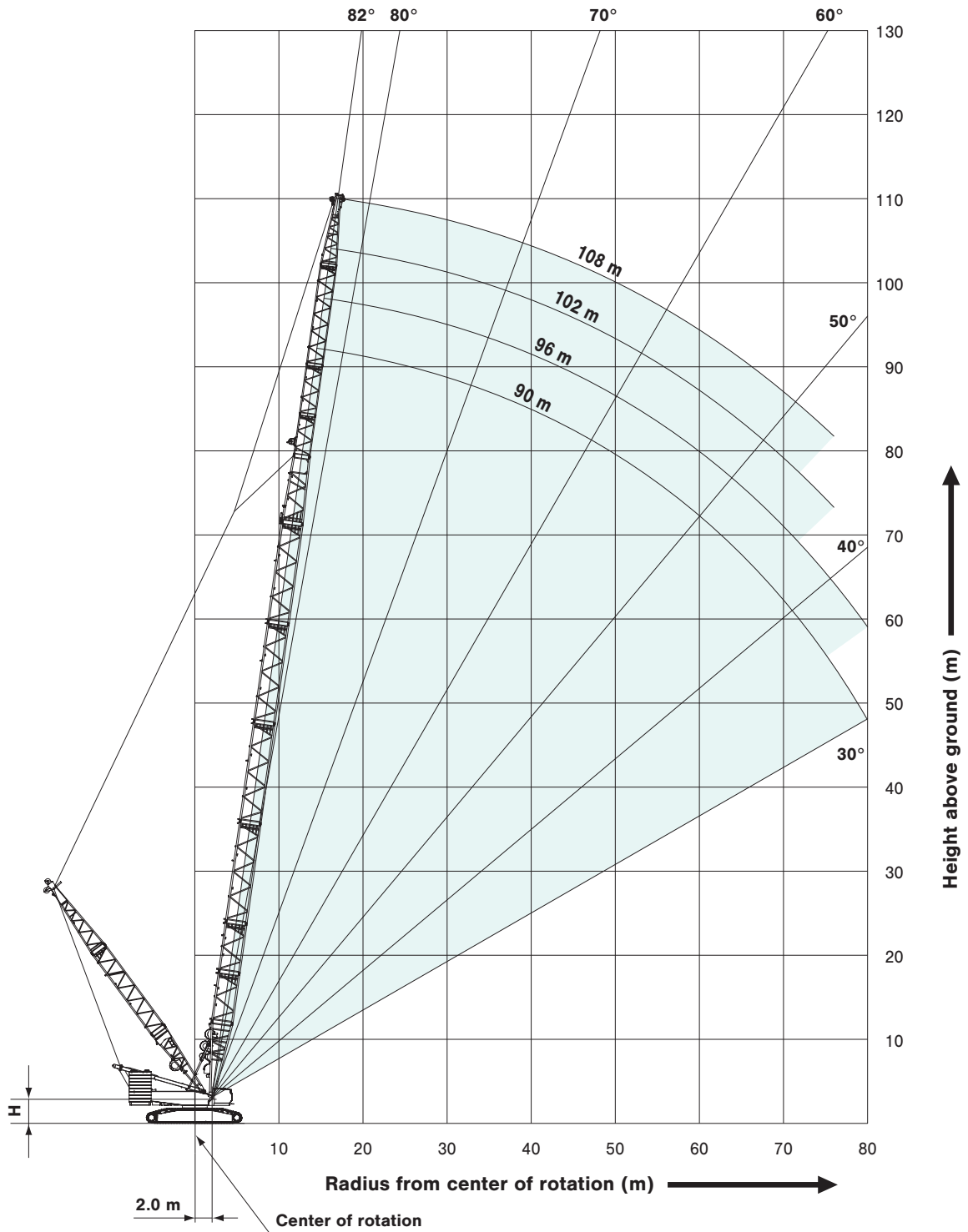

H=2.86 m Without quick connection ring  
 H=3.08 m With quick connection ring

## WORKING RANGES

### Heavy Fixed Jib (Type B1)

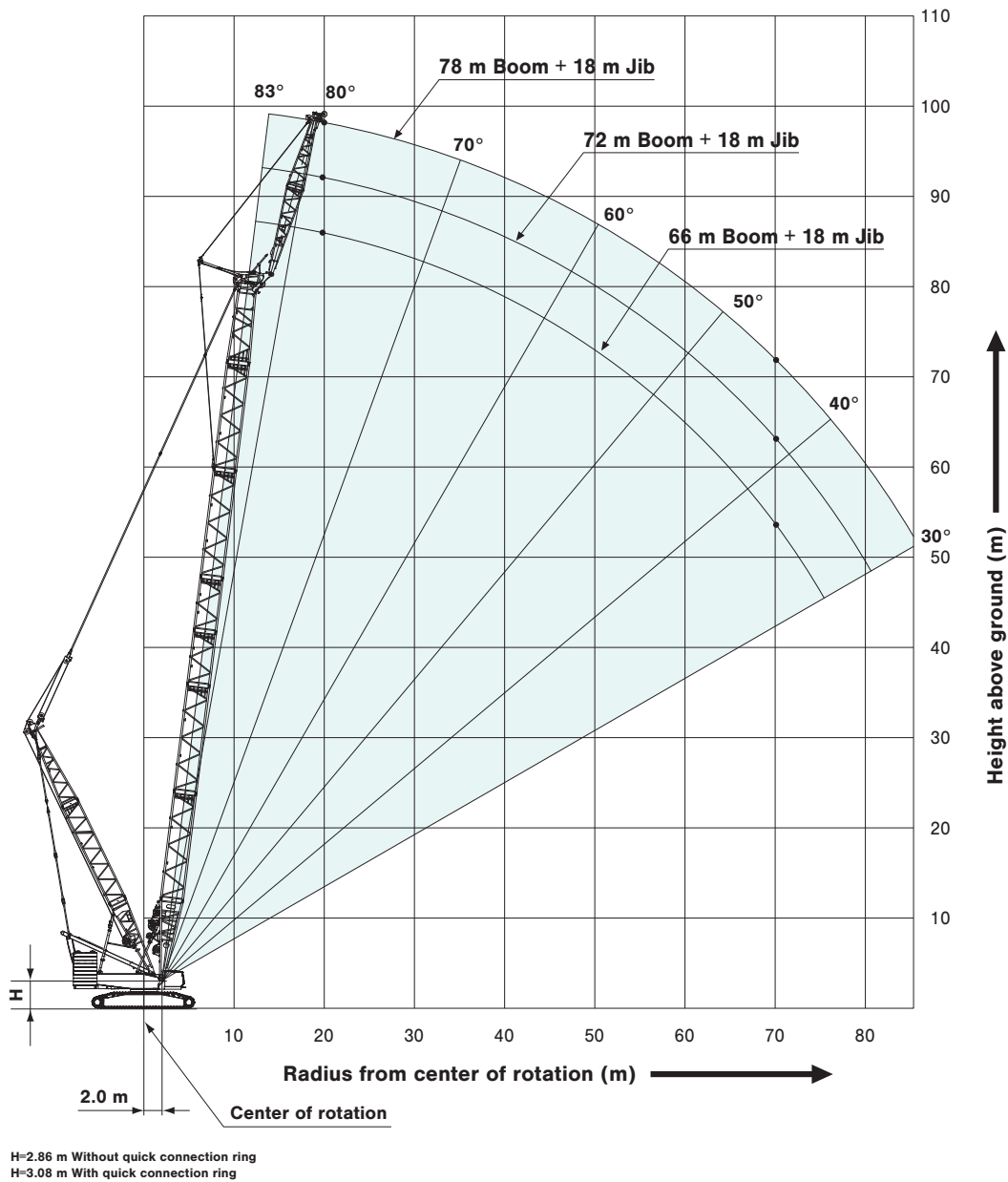



# Luffing Jib

Boom Angle: 86°

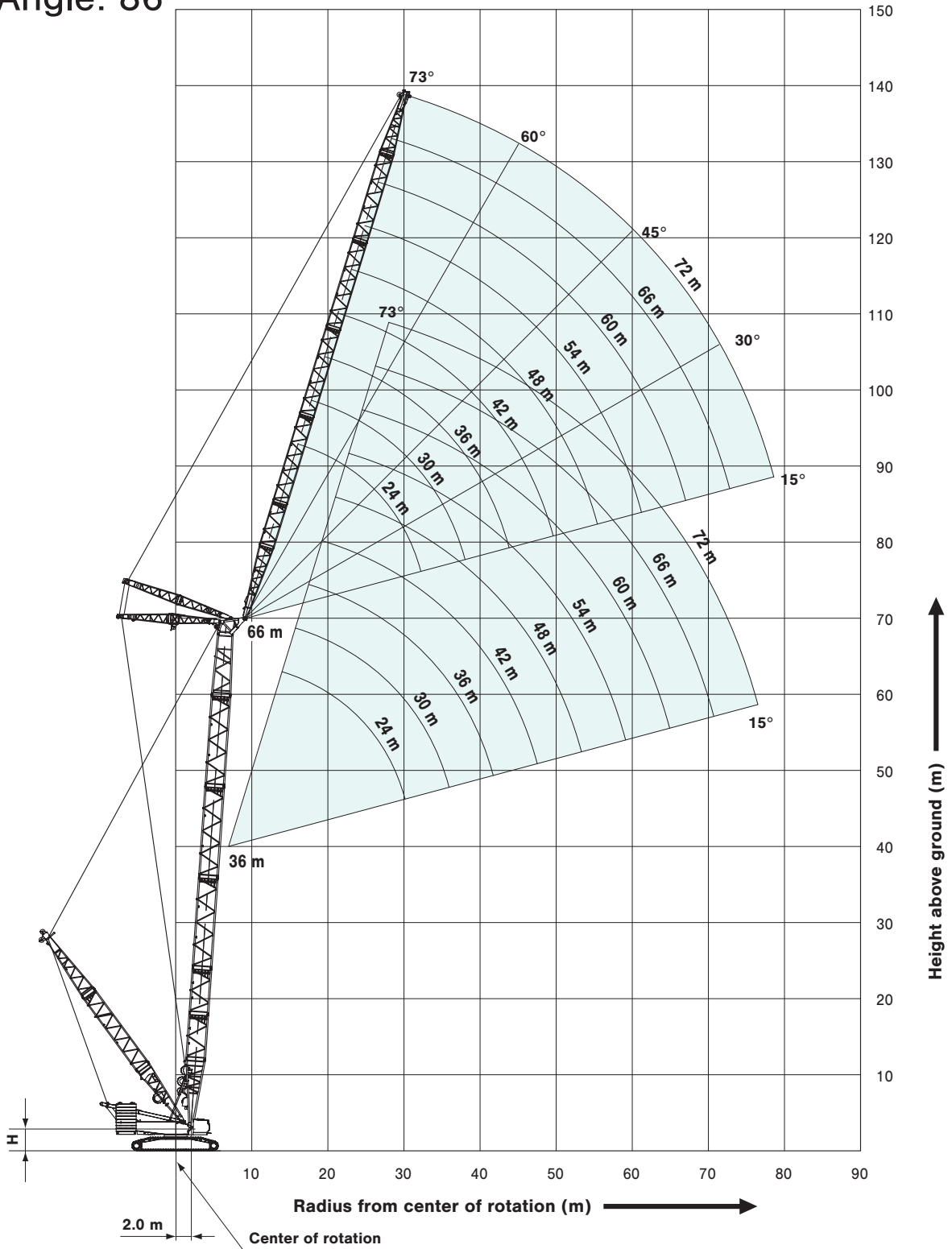

H=2.86 m Without quick connection ring  
 H=3.08 m With quick connection ring

# HEAVY LIFT

## WORKING RANGES

### Luffing Jib

Boom Angle: 76°

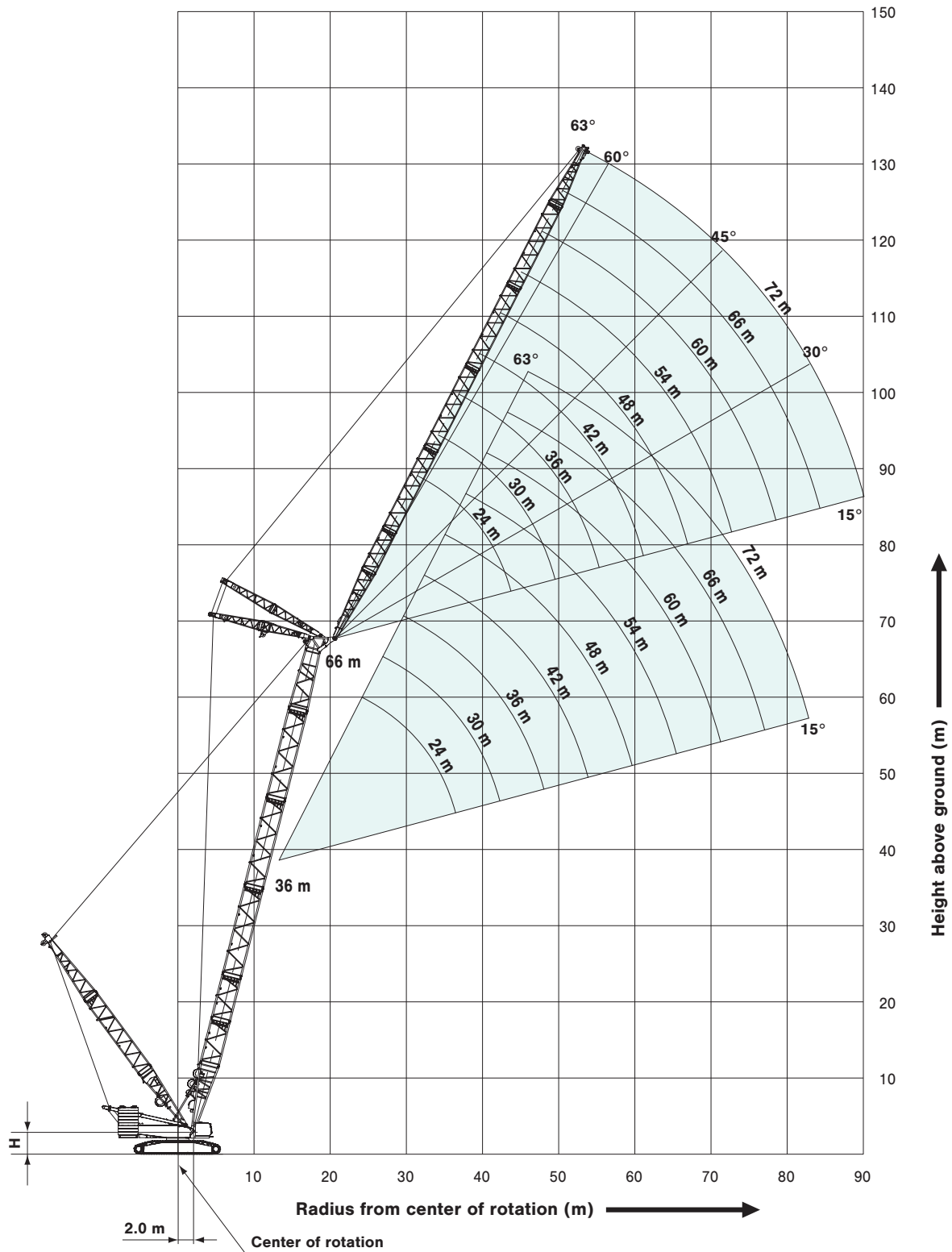

H=2.86 m Without quick connection ring  
H=3.08 m With quick connection ring

# Luffing Jib

Boom Angle: 66°

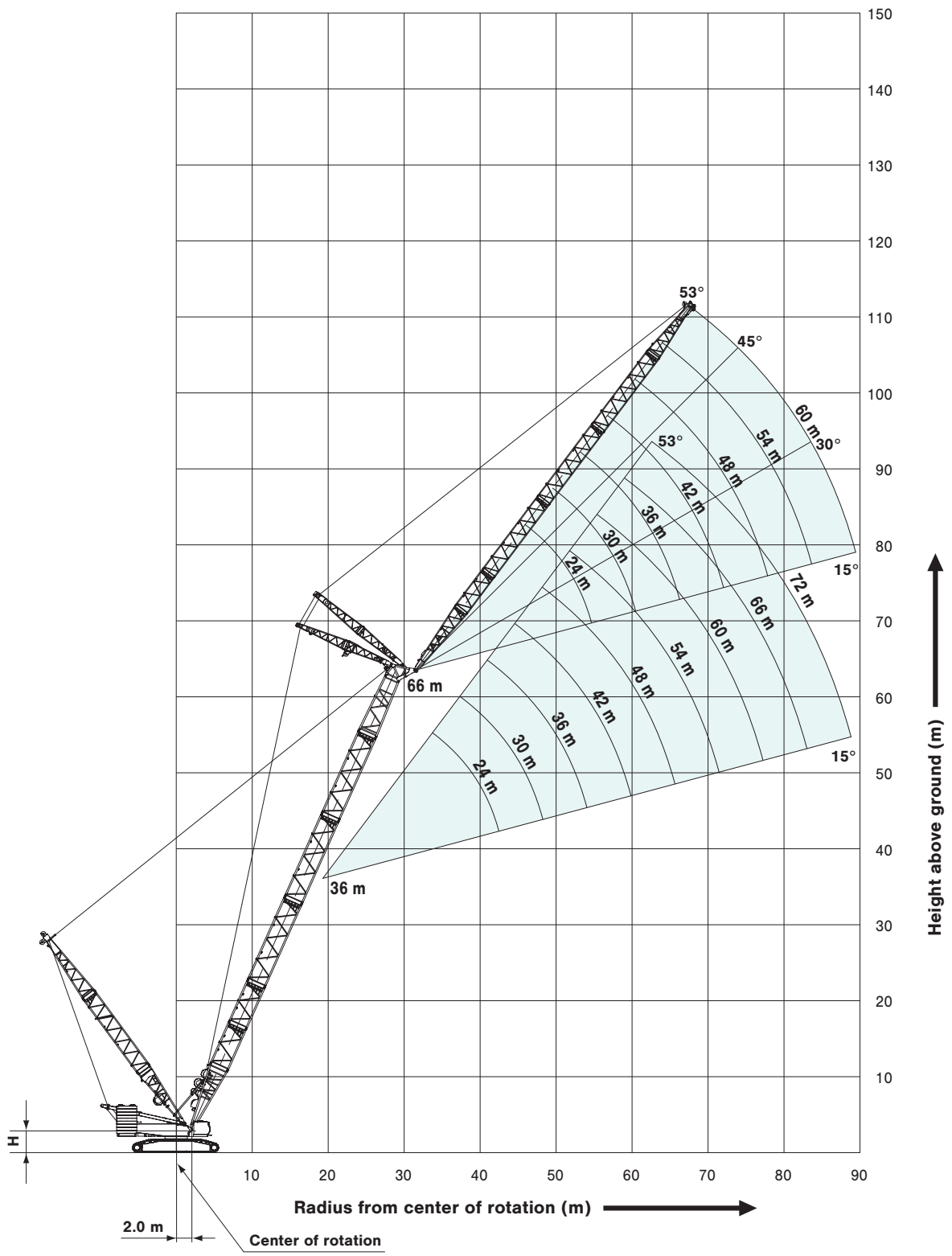

H=2.86 m Without quick connection ring  
 H=3.08 m With quick connection ring



## LIFTING CAPACITIES

### Heavy Duty Crane Boom Lifting Capacities

Unit: ton

Counterweight: 200.0 ton, Carbody weight: 50.0 ton  
HL Mast point radius: 11 m to 16 m

Boom Length (m) / Working Radius (m)	36.0	42.0	48.0	54.0	60.0	66.0	72.0	78.0	84.0	Boom Length (m) / Working Radius (m)
8.0	8.3 m/370.0									8.0
9.0	353.3	9.2 m/336.0								9.0
10.0	308.5	309.1	10.0 m/309.5	10.9 m/276.1	11.7 m/251.2					10.0
12.0	243.3	243.6	243.7	243.5	243.0	12.5 m/220.0	13.4 m/201.2			12.0
14.0	199.8	199.9	199.8	199.5	198.9	198.1	192.1	14.2 m/182.3	15.0 m/164.0	14.0
16.0	168.8	168.7	168.5	168.1	167.4	166.5	165.7	160.8	155.2	16.0
18.0	145.5	145.3	145.0	144.5	143.7	142.9	142.0	141.0	136.8	18.0
20.0	127.4	127.1	126.8	126.2	125.4	124.5	123.6	122.6	121.5	20.0
22.0	112.9	112.6	112.2	111.6	110.7	109.8	108.9	107.8	106.7	22.0
24.0	101.1	100.7	100.2	99.6	98.7	97.7	96.8	95.8	94.6	24.0
26.0	91.2	90.7	90.3	89.6	88.7	87.7	86.8	85.7	84.6	26.0
28.0	82.8	82.3	81.9	81.2	80.2	79.2	78.3	77.2	76.0	28.0
30.0	75.6	75.1	74.6	73.9	73.0	72.0	71.0	69.9	68.7	30.0
32.0	69.4	68.9	68.4	67.7	66.7	65.7	64.7	63.6	62.4	32.0
34.0	33.8 m/64.4	63.4	62.9	62.2	61.2	60.2	59.2	58.1	56.9	34.0
36.0		58.6	58.1	57.4	56.4	55.3	54.3	53.2	52.0	36.0
38.0		54.3	53.8	53.0	52.1	51.0	50.0	48.9	47.7	38.0
40.0		39.0 m/52.3	49.9	49.2	48.2	47.1	46.1	45.0	43.8	40.0
44.0			43.3	42.6	41.6	40.5	39.5	38.4	37.2	44.0
48.0			44.2 m/43.0	37.1	36.1	35.0	34.0	32.9	31.7	48.0
52.0				49.4 m/35.4	31.5	30.4	29.4	28.3	27.1	52.0
56.0					54.6 m/28.9	26.5	25.5	24.4	23.1	56.0
60.0						59.8 m/23.3	22.1	21.0	19.8	60.0
64.0							19.2	18.0	16.8	64.0
68.0							65.0 m/18.5	15.4	68.0 m/14.2	68.0
72.0								70.2 m/14.1		72.0
Reeves	28	24	24	20	20	16	16	16	12	Reeves

Note : Ratings according to EN13000.

Ratings shown in   are determined by the strength of the boom or other structural components.

Lifting capacities may vary depending on hook used or with / without auxiliary sheave.

Please refer rated chart in operator's cabin.

Please refer Page 21 for Crane Boom Supplemental Data.



## Long Boom Lifting Capacities

Unit: ton

Counterweight: 200.0 ton, Carbody weight: 50.0 ton  
HL Mast point radius: 11 m to 16 m

Working Radius (m)	90.0		96.0		102.0		108.0		Working Radius (m)
	Boom Length (m)	Working Radius (m)	Boom Length (m)	Working Radius (m)	Boom Length (m)	Working Radius (m)	Boom Length (m)	Working Radius (m)	
14.0	15.0 m/98.0	15.8 m/98.0							14.0
16.0	98.0	98.0	16.6 m/84.0	17.5 m/84.0					16.0
18.0	98.0	98.0	84.0	84.0					18.0
20.0	98.0	98.0	84.0	84.0					20.0
22.0	95.7	95.7	84.0	84.0					22.0
24.0	87.7	87.7	84.0	84.0					24.0
26.0	81.0	81.0	81.0	81.0					26.0
28.0	75.2	75.2	75.2	75.0					28.0
30.0	70.2	70.2	70.2	68.9					30.0
32.0	65.4	65.3	64.1	63.4					32.0
34.0	59.9	59.7	58.5	58.3					34.0
36.0	55.0	54.8	53.6	53.4					36.0
38.0	50.7	50.5	49.3	49.1					38.0
40.0	46.8	46.6	45.4	45.2					40.0
44.0	40.2	40.0	38.7	38.5					44.0
48.0	34.7	34.5	33.2	33.0					48.0
52.0	30.1	29.8	28.6	28.4					52.0
56.0	26.1	25.9	24.7	24.4					56.0
60.0	22.7	22.5	21.3	21.1					60.0
64.0	19.8	19.5	18.2	18.0					64.0
68.0	17.1	16.7	15.4	15.2					68.0
72.0	14.6	14.2	12.9	12.7					72.0
76.0	12.4	12.0	76.0 m/10.7	76.0 m/10.5					76.0
80.0	10.5	80.0 m/10.1							80.0
84.0	80.1 m/10.5								84.0
Reeves	7	7	6	6					Reeves

Note :

Ratings according to EN13000.

Ratings shown in   are determined by the strength of the boom or other structural components.

Lifting capacities may vary depending on hook used or with / without auxiliary sheave.

Please refer rated chart in operator's cabin.

Please refer Page 21 for Crane Boom Supplemental Data.

## Heavy Fixed Jib (Type B1) Lifting Capacities

Unit: ton

Counterweight: 200.0 ton, Carbody weight: 50.0 ton  
HL Mast point radius: 11 m

Working Radius (m)	18.0			Working Radius (m)
	66.0	72.0	78.0	
20.0	120.0	120.0	117.0	20.0
22.0	107.9	107.2	104.8	22.0
24.0	95.5	94.6	93.7	24.0
26.0	85.1	84.2	83.2	26.0
28.0	76.3	75.4	74.4	28.0
30.0	68.8	67.8	66.8	30.0
34.0	56.6	55.6	54.4	34.0
38.0	47.1	46.0	44.9	38.0
42.0	39.5	38.4	37.2	42.0
46.0	33.3	32.2	31.0	46.0
50.0	28.2	27.0	25.8	50.0
54.0	23.8	22.6	21.4	54.0
58.0	20.1	18.9	17.6	58.0
62.0	16.9	15.7	14.4	62.0
66.0	14.1	12.9	11.5	66.0
70.0	11.6	10.4	9.1	70.0
Reeves	10	10	10	Reeves

Note :

Ratings according to EN13000.

Ratings shown in   are determined by the strength of the boom or other structural components.

Lifting capacities may vary depending on hook used or with / without auxiliary sheave.

Please refer rated chart in operator's cabin.

Ratings enclosed in gray-color box in the table require double-drum specifications.

Please refer Page 21 for Heavy Fixed Jib Supplemental Data.



## LIFTING CAPACITIES

### Luffing Boom Lifting Capacities

Unit: ton

Counterweight: 200.0 ton, Carbody weight: 50.0 ton  
HL Mast point radius: 11 m to 16 m

Working Radius (m) \ Boom Length (m)	36.0	42.0	48.0	54.0	60.0	66.0	72.0	78.0	84.0	Working Radius (m) \ Boom Length (m)
8.0	8.5 m/300.0									8.0
9.0	300.0	9.3 m/300.0								9.0
10.0	286.5	287.1	10.2 m/280.5	11.0 m/252.1	11.8 m/225.4					10.0
12.0	224.9	225.3	225.0	224.6	221.9	12.7 m/199.7	13.5 m/178.2			12.0
14.0	184.0	184.2	183.8	183.3	183.0	178.8	171.2	14.3 m/160.6	15.2 m/145.2	14.0
16.0	154.8	154.9	154.6	153.9	153.4	152.7	147.4	142.2	137.0	16.0
18.0	132.9	132.9	132.6	132.0	131.4	129.7	128.5	124.1	119.7	18.0
20.0	116.0	115.9	115.5	114.8	114.3	113.5	112.6	109.5	105.6	20.0
22.0	102.4	102.2	101.9	101.2	100.6	99.8	98.9	97.3	93.8	22.0
24.0	91.3	91.1	90.7	90.1	89.6	88.6	87.7	87.1	84.0	24.0
26.0	82.0	81.8	81.4	80.8	80.3	79.3	78.3	77.6	75.5	26.0
28.0	74.2	74.0	73.5	72.9	72.4	71.5	70.4	69.7	68.2	28.0
30.0	67.5	67.2	66.8	66.1	65.7	64.8	63.8	63.0	61.8	30.0
32.0	61.6	61.4	60.9	60.3	59.8	58.9	58.0	57.1	56.1	32.0
34.0	33.9 m/56.6	56.3	55.8	55.1	54.7	53.8	52.8	52.0	51.1	34.0
36.0		51.7	51.3	50.6	50.2	49.3	48.3	47.4	46.4	36.0
38.0		47.7	47.3	46.6	46.1	45.3	44.3	43.6	42.6	38.0
40.0		39.1 m/45.6	43.6	43.0	42.5	41.7	40.7	40.0	39.0	40.0
44.0			37.4	36.8	36.3	35.5	34.5	33.7	32.7	44.0
48.0			44.3 m/37.0	31.6	31.2	30.4	29.3	28.5	27.3	48.0
52.0				49.5 m/29.9	26.9	26.0	25.0	23.9	22.6	52.0
56.0					54.7 m/24.3	22.4	21.2	20.0	18.7	56.0
60.0						59.9 m/19.2	18.0	16.7	15.3	60.0
64.0							15.4	14.0	12.5	64.0
68.0							65.1 m/14.8	11.7	10.0	68.0
72.0								70.3 m/10.5	72.0 m/7.7	72.0
<b>Reeves</b>	24	24	20	20	16	16	12	12	12	<b>Reeves</b>

Note : Ratings according to EN13000.

Ratings shown in   are determined by the strength of the boom or other structural components.

Lifting capacities may vary depending on hook used or with / without auxiliary sheave.

Please refer rated chart in operator's cabin.

Ratings enclosed in gray color box in the table require duple-drum specifications.

Please refer Page 21 for Crane Boom Supplemental Data.



# Luffing Jib Lifting Capacity

Unit: ton

**Counterweight: 200.0 ton, Carbody weight: 50.0 ton  
HL Mast point radius: 16 m**

36.0 m Boom Length	36.0																											36.0								
	24.0			30.0			36.0			42.0			48.0			54.0			60.0			66.0			72.0											
	86°			76°			66°			86°			76°			66°			86°			76°			66°				86°			76°			66°	
Working Radius (m)	14.4	15.0	16.0	17.0	18.0	20.0	22.0	24.0	26.0	28.0	30.0	34.0	38.0	42.0	46.0	50.0	54.0	58.0	62.0	66.0	70.0	74.0	78.0	82.0	86.0	Reeves	16	16	12	12	12	8	8	8	8	Reeves
14.4	15.0	16.0	17.0	18.0	20.0	22.0	24.0	26.0	28.0	30.0	34.0	38.0	42.0	46.0	50.0	54.0	58.0	62.0	66.0	70.0	74.0	78.0	82.0	86.0	Reeves	16	16	12	12	12	8	8	8	8	Reeves	

42.0 m Boom Length	42.0																											42.0								
	24.0			30.0			36.0			42.0			48.0			54.0			60.0			66.0			72.0											
	86°			76°			66°			86°			76°			66°			86°			76°			66°				86°			76°			66°	
Working Radius (m)	15.4	16.0	17.0	18.0	20.0	22.0	24.0	26.0	28.0	30.0	34.0	38.0	42.0	46.0	50.0	54.0	58.0	62.0	66.0	70.0	74.0	78.0	82.0	86.0	90.0	Reeves	16	16	12	12	12	8	8	8	8	Reeves
15.4	16.0	17.0	18.0	20.0	22.0	24.0	26.0	28.0	30.0	34.0	38.0	42.0	46.0	50.0	54.0	58.0	62.0	66.0	70.0	74.0	78.0	82.0	86.0	90.0	Reeves	16	16	12	12	12	8	8	8	8	Reeves	

Note : Ratings according to EN13000.

Ratings shown in   are determined by the strength of the boom or other structural components.

Lifting capacities may vary depending on hook used or with / without auxiliary sheave.

Please refer rated chart in operator's cabin.

Ratings enclosed in gray color box in the table require double-drum specifications.

Please refer Page 23 to 25 for Luffing Jib Supplemental Data.



## LIFTING CAPACITIES

### Luffing Jib Lifting Capacity

Unit: ton

Counterweight: 200.0 ton, Carbody weight: 50.0 ton  
HL Mast point radius: 16 m

48.0 m Boom Length	48.0																											Boom length (m)					
	24.0			30.0			36.0			42.0			48.0			54.0			60.0			66.0			72.0			Jib length (m)					
	86° 76° 66°			86° 76° 66°			86° 76° 66°			86° 76° 66°			86° 76° 66°			86° 76° 66°			86° 76° 66°			86° 76° 66°			86° 76° 66°			Boom angle					
16.2	179.7																										16.2						
17.0	171.3			165.8																							17.0						
18.0	162.0			156.8																							18.0						
20.0	146.7			142.3				137.3																			20.0						
22.0	132.4			129.5				125.9			121.2																22.0						
24.0	118.2			117.5				115.5			112.1			108.0			104.7										24.0						
26.0	106.5			105.9				106.1			103.5			101.7			98.9				89.5						26.0						
28.0	96.9	87.7		96.2				96.4			95.7			94.4			91.8				88.5			77.0			28.0						
30.0	88.7	80.3		88.1				88.3			87.5			86.8			85.6				83.3			76.2		66.3	30.0						
34.0		68.3		75.1	67.4			75.3	67.4		74.5			73.8			74.0				73.1			70.9		59.2	34.0						
38.0		59.3			58.4			65.3	58.4		64.6	57.5			63.9			64.1			63.4			62.6		53.8	38.0						
42.0			46.7		51.3			57.6	51.3		56.8	50.4			56.1	49.6			56.3	49.2			55.6		54.8		48.6	42.0					
46.0			41.5			40.5		45.6			50.6	44.7			49.8	43.9			50.0	43.9			49.3	42.2	48.5		44.8	46.0					
50.0					36.2		41.0	36.1			40.1	35.1	35.1			44.7	39.2			44.8	39.3			44.1	38.5	43.3	36.0	40.4	34.4	50.0			
54.0							32.6			36.2	31.6	31.6	30.7			40.4	35.3			39.8	34.6			39.0	33.7	36.9	32.9	36.9	32.9	54.0			
58.0								29.6			28.6		27.7			36.8	32.0	27.1			36.1	31.3			35.3	30.4	34.1	29.6	34.1	29.6	58.0		
62.0											26.1		29.3	25.2			29.2	25.0	33.0			28.4	23.0	32.1	27.5		31.4	26.8	31.4	26.8	62.0		
66.0														23.0			26.7	22.8				26.0	22.0	29.4	25.1	19.1	28.7	24.3	28.7	24.3	66.0		
70.0																		20.9				23.8	20.0	27.1	22.9	18.8	26.3	22.2	15.7	26.3	22.2	70.0	
74.0																						19.1	22.0	18.2	21.1	17.0	24.3	20.3	15.7	24.3	20.3	74.0	
78.0																															18.6	14.5	78.0
82.0																															17.1	13.1	82.0
86.0																															11.8	11.8	86.0
90.0																															10.8	10.8	90.0
Reeves		16			16				12			12			8			8			8			8			8			8		Reeves	

54.0 m Boom Length	54.0																											Boom length (m)						
	24.0			30.0			36.0			42.0			48.0			54.0			60.0			66.0			72.0			Jib length (m)						
	86° 76° 66°			86° 76° 66°			86° 76° 66°			86° 76° 66°			86° 76° 66°			86° 76° 66°			86° 76° 66°			86° 76° 66°			86° 76° 66°			Boom angle						
17.0	165.2																													17.0				
18.0	156.4			151.4																										18.0				
20.0	142.0			137.6				132.8																						20.0				
22.0	129.3			125.4				121.9				117.3																		22.0				
24.0	117.6			115.2				112.0				108.7				104.6														24.0				
26.0	106.0			105.3				104.4				101.5				98.8						93.5								26.0				
28.0	96.3			95.6				95.9				94.3				91.7						89.1			82.1					28.0				
30.0	88.1	78.3		87.5				87.8				87.0				85.6						83.1			80.9		72.0			62.2	30.0			
34.0		66.6		74.6	65.6			74.8				74.0				73.3						73.0			71.0		68.9		59.7	34.0				
38.0		57.7			56.8			64.9	56.8			64.2	55.9			63.4						63.7			63.0		61.1		53.7	38.0				
42.0			44.3		49.8			57.2	49.9			56.4	49.0			55.7	48.1					55.9			55.2		54.5		48.6	42.0				
46.0			39.3		44.3	38.2		44.3				50.2	43.4			49.4	42.5					49.6	41.3		49.0	39.5	48.2		44.2	46.0				
50.0					34.1		39.7	34.1				38.8				44.3	37.9					44.4	38.0		43.8	37.2	43.0	33.5	40.4	50.0				
54.0						30.8		30.7				35.0	29.6			40.1	34.1					40.1	34.2		39.5	33.4	38.7	32.5	37.1	28.5	54.0			
58.0									27.8			31.8	26.8			30.9	25.8	36.5				30.9			35.8	30.2	35.0	29.3	34.2	28.5	58.0			
62.0												24.3				28.2	23.4					28.1	21.7		32.7	27.4	31.8	26.5	31.1	25.7	62.0			
66.0												22.3					21.2					25.7	21.1		30.0	25.0	18.1	29.1	24.1	28.4	23.3	66.0		
70.0																		19.3							19.1		22.9	18.1	26.8	22.0	14.6	26.1	21.2	70.0
74.0																									17.4		21.1	16.4	20.1	14.6	24.0	19.3	11.6	74.0
78.0																									15.9			14.9	18.5	13.7	17.6	11.6	78.0	
82.0																															12.4	16.1	11.4	82.0
86.0																															11.2	14.8	10.2	86.0
90.0																															10.3		9.2	90.0
94.0																																	8.3	94.0
Reeves		16			12			12			12			8			8			8			8			8			8		Reeves			

Note : Ratings according to EN13000.

Ratings shown in   are determined by the strength of the boom or other structural components.

Lifting capacities may vary depending on hook used or with / without auxiliary sheave.

Please refer rated chart in operator's cabin.

Ratings enclosed in gray color box in the table require duple-drum specifications.

Please refer Page 23 to 25 for Luffing Jib Supplemental Data.





# SUPER HEAVY LIFT

## BOOM AND JIB ARRANGEMENTS

### Heavy Duty Crane Boom Arrangements

Boom length m (ft)	Boom arrangement
36 (118)	※
42 (138)	※
48 (157)	※
54 (177)	※
60 (197)	※
66 (217)	※
72 (236)	※
78 (256)	※
84 (276)	※

Symbol	Boom Length	Remarks
	9.0 m (29.5 ft)	Boom Base
	8.0 m (26.2 ft)	Taper Boom Insert
	6.0 m (19.7 ft)	Boom Insert
	12.0 m (39.4 ft)	Boom Insert
	1.0 m (3.3 ft)	Heavy Boom Tip

※ indicates the most flexible combination of insert heavy duty booms, which can be modified to form all shorter heavy duty boom arrangements.

### Luffing Boom Arrangements for Crane

Boom length m (ft)	Boom arrangement
36 (118)	※
42 (138)	※
48 (157)	※
54 (177)	※
60 (197)	※
66 (217)	※
72 (236)	※
78 (256)	※
84 (276)	※

Symbol	Boom Length	Remarks
	9.0 m (29.5 ft)	Boom Base
	8.0 m (26.2 ft)	Taper Boom Insert
	6.0 m (19.7 ft)	Boom Insert
	12.0 m (39.4 ft)	Boom Insert
	1.0 m (3.3 ft)	Luffing Boom Tip

※ indicates the most flexible combination of insert luffing booms, which can be modified to form all shorter luffing boom arrangements.

# Long Boom Arrangements

Boom length m (ft)	Boom arrangement
90 (295)	
96 (315)	※ 
102 (335)	※   
108 (354)	※ 
114 (374)	※
120 (394)	※ 
126 (413)	※

Symbol	Boom Length	Remarks
	9.0 m (29.5 ft)	Boom Base
	8.0 m (26.2 ft)	Taper Boom Insert
	6.0 m (19.7 ft)	Boom Insert
	12.0 m (39.4 ft)	Boom Insert
	5.0 m (16.4 ft)	Special Long Boom Insert
	6.0 m (19.7 ft)	Long Boom Insert
	12.0 m (39.4 ft)	Long Boom Insert
	8.0 m (26.2 ft)	Long Boom Tip

※ indicates the most flexible combination of insert long booms, which can be modified to form all shorter long boom arrangements.

# SUPER HEAVY LIFT

## BOOM AND JIB ARRANGEMENTS

### Heavy Fixed Jib Boom Arrangements (Type B2)

Boom length m (ft)	Boom arrangement
66 (217)	※
72 (236)	※
78 (256)	※

Symbol	Boom Length	Remarks
	9.0 m (29.5 ft)	Boom Base
	8.0 m (26.2 ft)	Taper Boom Insert
	6.0 m (19.7 ft)	Boom Insert
	12.0 m (39.4 ft)	Boom Insert
	1.0 m (3.3 ft)	Boom Tip

↗ mark shows the guy line installing position when the fixed jib is used.  
 ※ indicates the most flexible combination of insert luffing booms, which can be modified to form all shorter luffing boom arrangements.

### Heavy Fixed Jib Arrangements (Type B2)

Jib length m (ft)	Jib arrangement
18 (59)	

Symbol	Jib Length	Remarks
	10.0 m (32.8 ft)	Jib Base
	8.0 m (26.2 ft)	Jib Tip

### Heavy Fixed Jib Boom Arrangements (Type C)

Boom length m (ft)	Boom arrangement
84 (276)	※
90 (296)	※
96 (316)	※
102 (336)	※

Symbol	Boom Length	Remarks
	9.0 m (29.5 ft)	Boom Base
	8.0 m (26.2 ft)	Taper Boom Insert
	6.0 m (19.7 ft)	Boom Insert
	12.0 m (39.4 ft)	Boom Insert
	1.0 m (3.3 ft)	Boom Tip

↗ mark shows the guy line installing position when the fixed jib is used.  
 ※ indicates the most flexible combination of insert heavy duty booms, which can be modified to form all shorter heavy duty boom arrangements.

### Heavy Fixed Jib Arrangements (Type C)

Jib length m (ft)	Jib arrangement
18 (59)	

Symbol	Jib Length	Remarks
	10.0 m (32.8 ft)	Jib Base
	8.0 m (26.2 ft)	Jib Tip

# Luffing Boom Arrangements for Luffing

Boom length m (ft)	Boom arrangement
36 (118)	※
42 (138)	※
48 (157)	※
54 (177)	※
60 (197)	※
66 (217)	※
72 (236)	※
78 (256)	※
84 (276)	※

Symbol	Boom Length	Remarks
	9.0 m (29.5 ft)	Boom Base
	8.0 m (26.2 ft)	Taper Boom Insert
	6.0 m (19.7 ft)	Boom Insert
	12.0 m (39.4 ft)	Boom Insert
	1.0 m (3.3 ft)	Boom Tip

※ indicates the most flexible combination of insert luffing booms, which can be modified to form all shorter luffing boom arrangements.

# Luffing Jib Arrangements

Jib length m (ft)	Jib arrangement
24 (79)	
30 (98)	※
36 (118)	※
42 (136)	※
48 (157)	※
54 (177)	※
60 (197)	※
66 (217)	※
72 (236)	※
78 (256)	※
84 (276)	※

Symbol	Jib Length	Remarks
	10.0 m (32.8 ft)	Jib Base
	6.0 m (19.7 ft)	Jib Insert
	12.0 m (39.4 ft)	Jib Insert
	8.0 m (26.2 ft)	Jib Tip

※ indicates the most flexible combination of insert luffing jibs, which can be modified to form all shorter luffing jib arrangements.

# SHL MAST

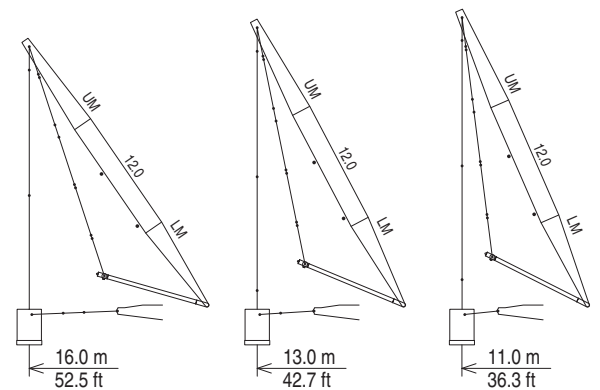

Symbol	Mast Length	Remarks
	9.0 m (29.5 ft)	Mast Base
	12.0 m (39.4 ft)	Mast Insert
	9.0 m (29.5 ft)	Mast Tip

# SUPER HEAVY LIFT

## WORKING RANGES

### Heavy Duty Crane Boom

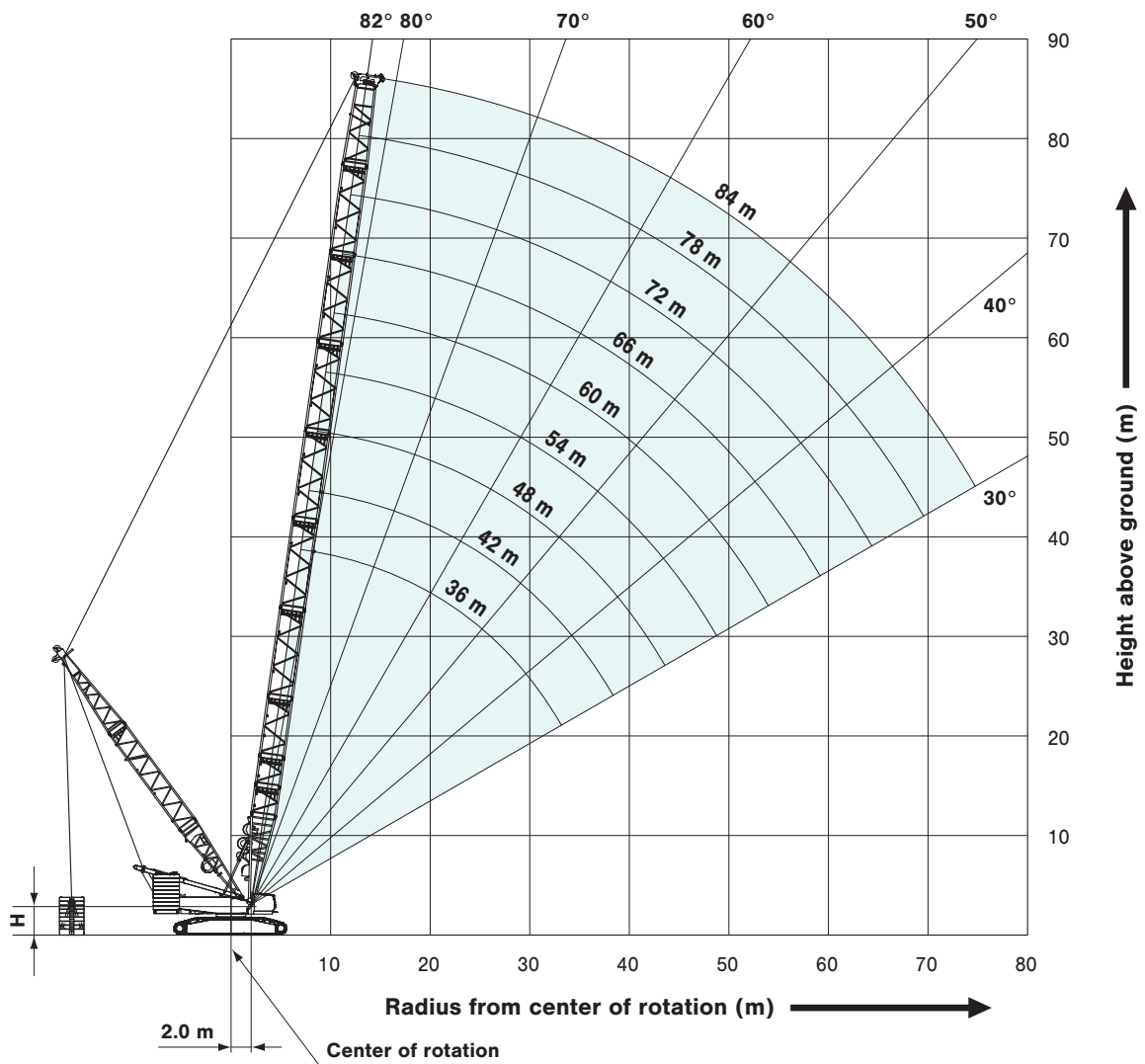

H=2.86 m Without quick connection ring  
H=3.08 m With quick connection ring

# Luffing Boom

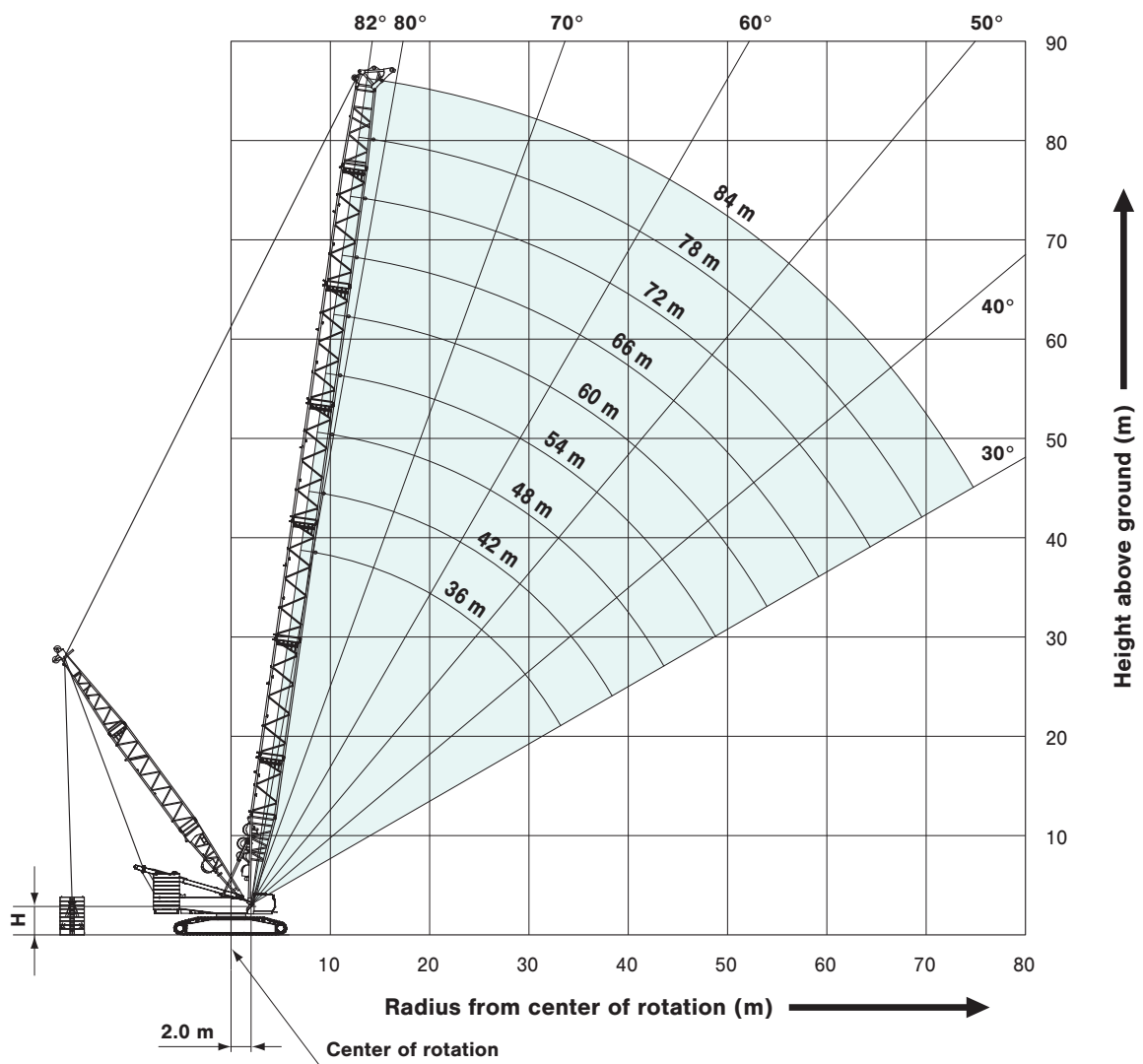

H=2.86 m Without quick connection ring  
 H=3.08 m With quick connection ring

# SUPER HEAVY LIFT

## WORKING RANGES

### Long Boom

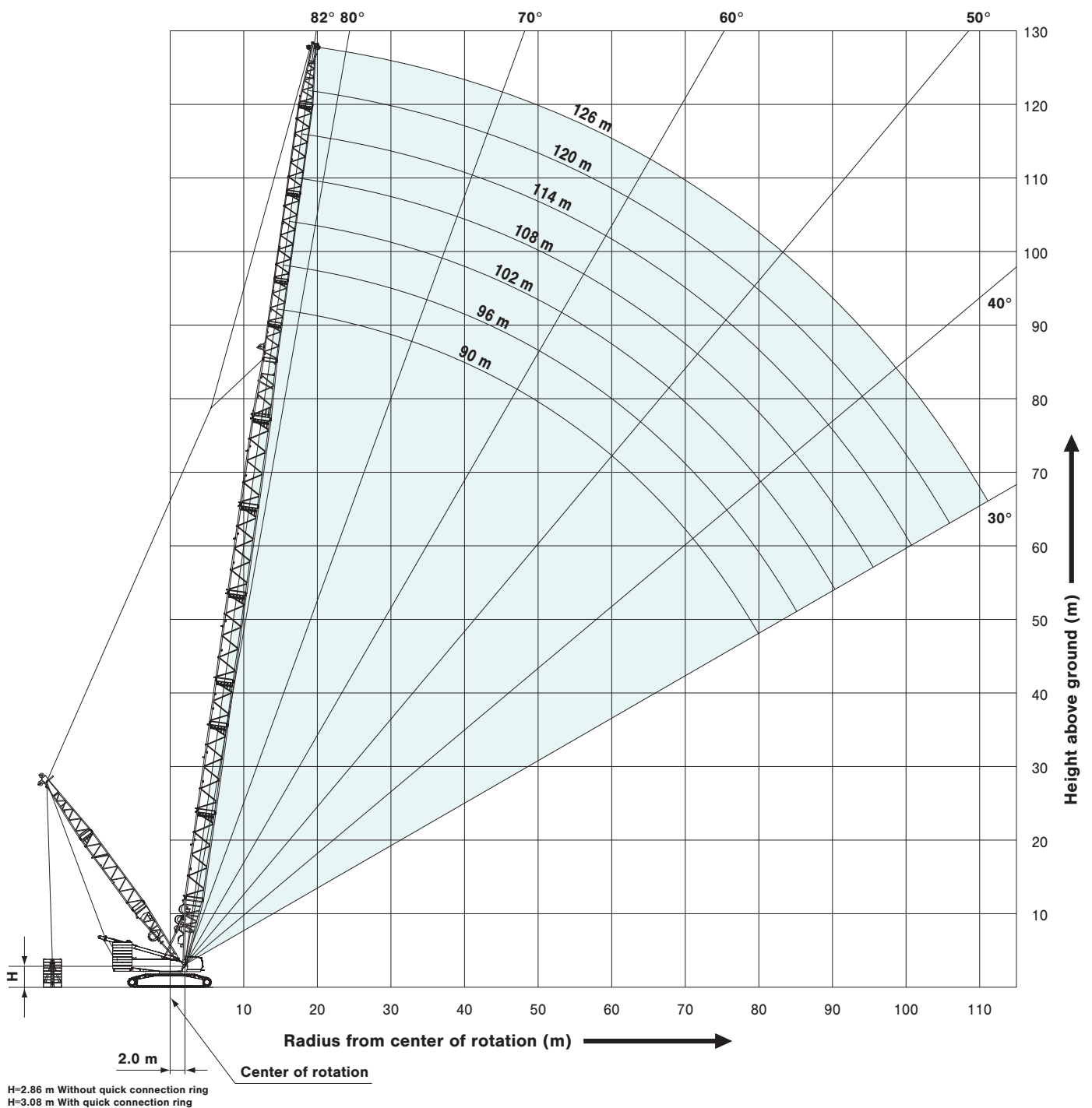



# Heavy Fixed Jib (Type B2)

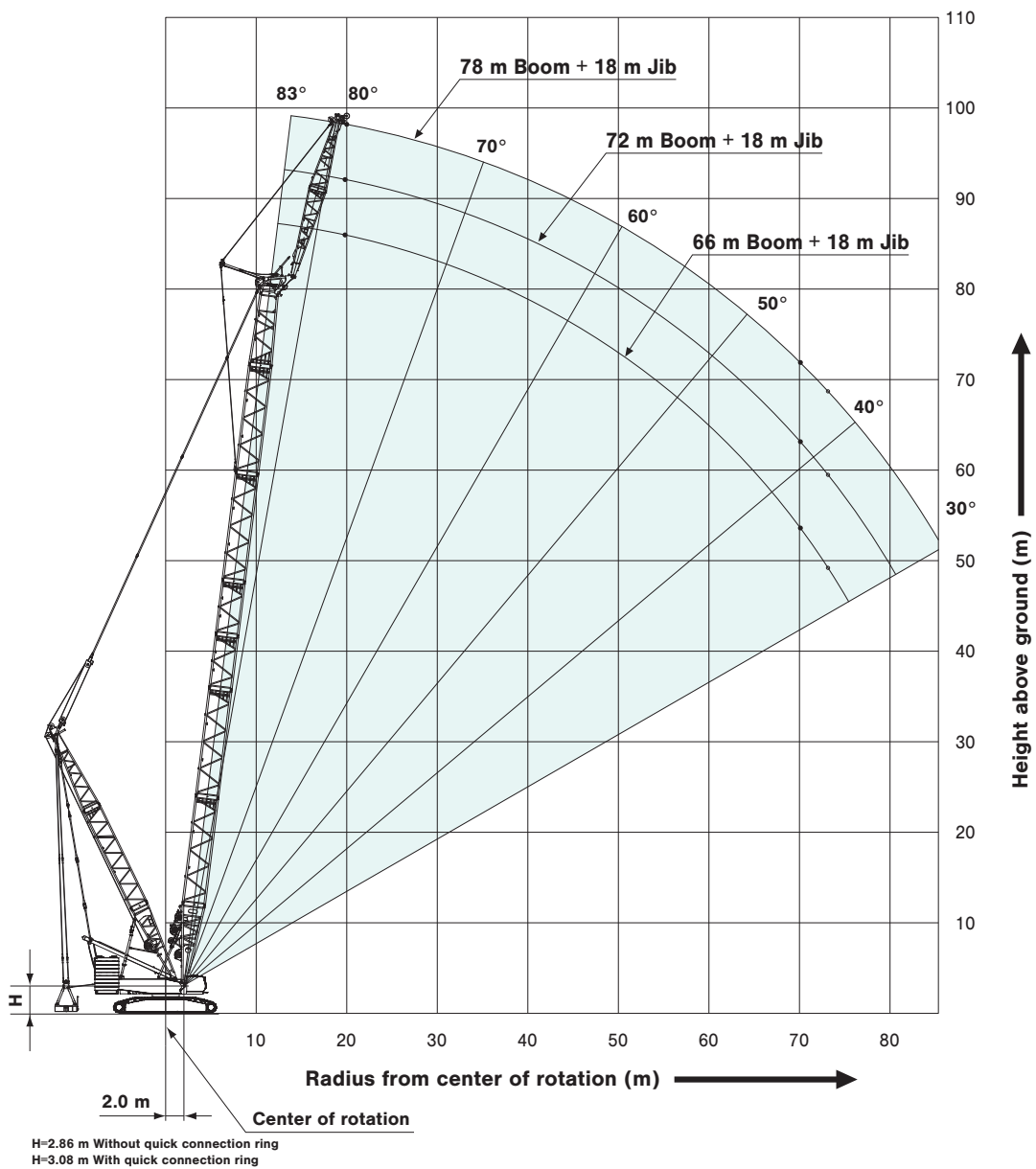

# SUPER HEAVY LIFT

## WORKING RANGES

### Heavy Fixed Jib (Type C)

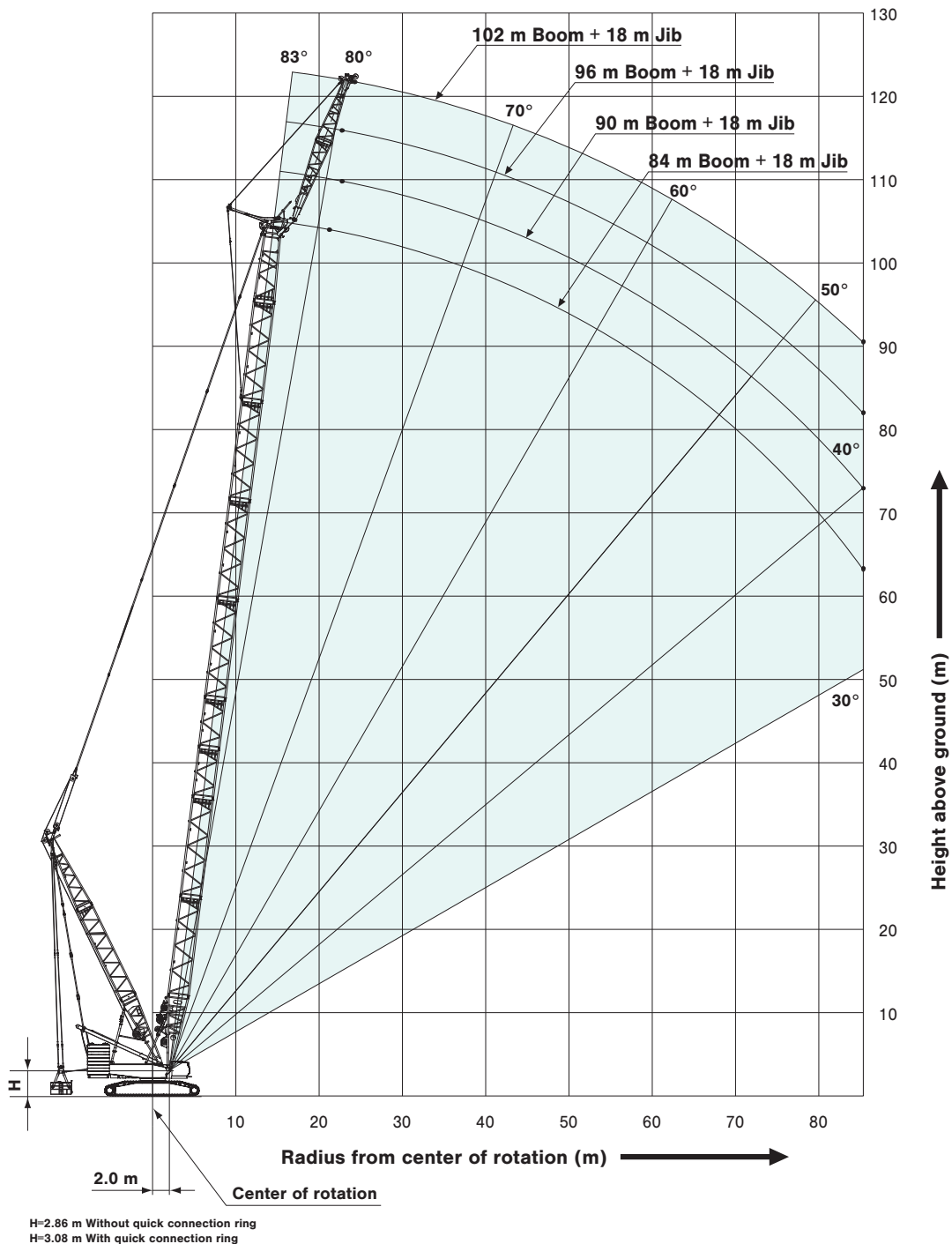

# Luffing Jib

Boom Angle: 86°

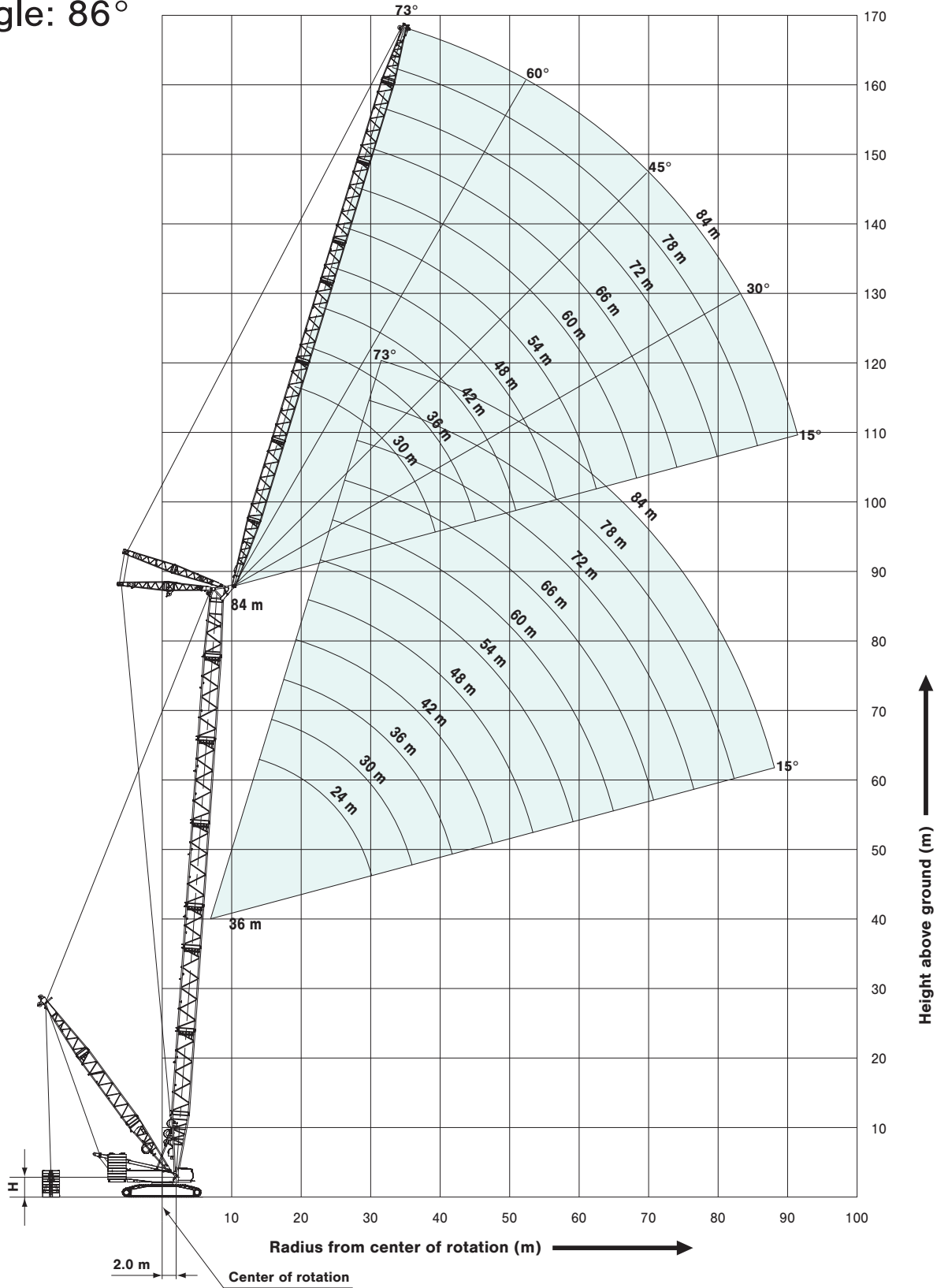

H=2.86 m Without quick connection ring  
 H=3.08 m With quick connection ring

# SUPER HEAVY LIFT

## WORKING RANGES

### Luffing Jib

Boom Angle:  
76°

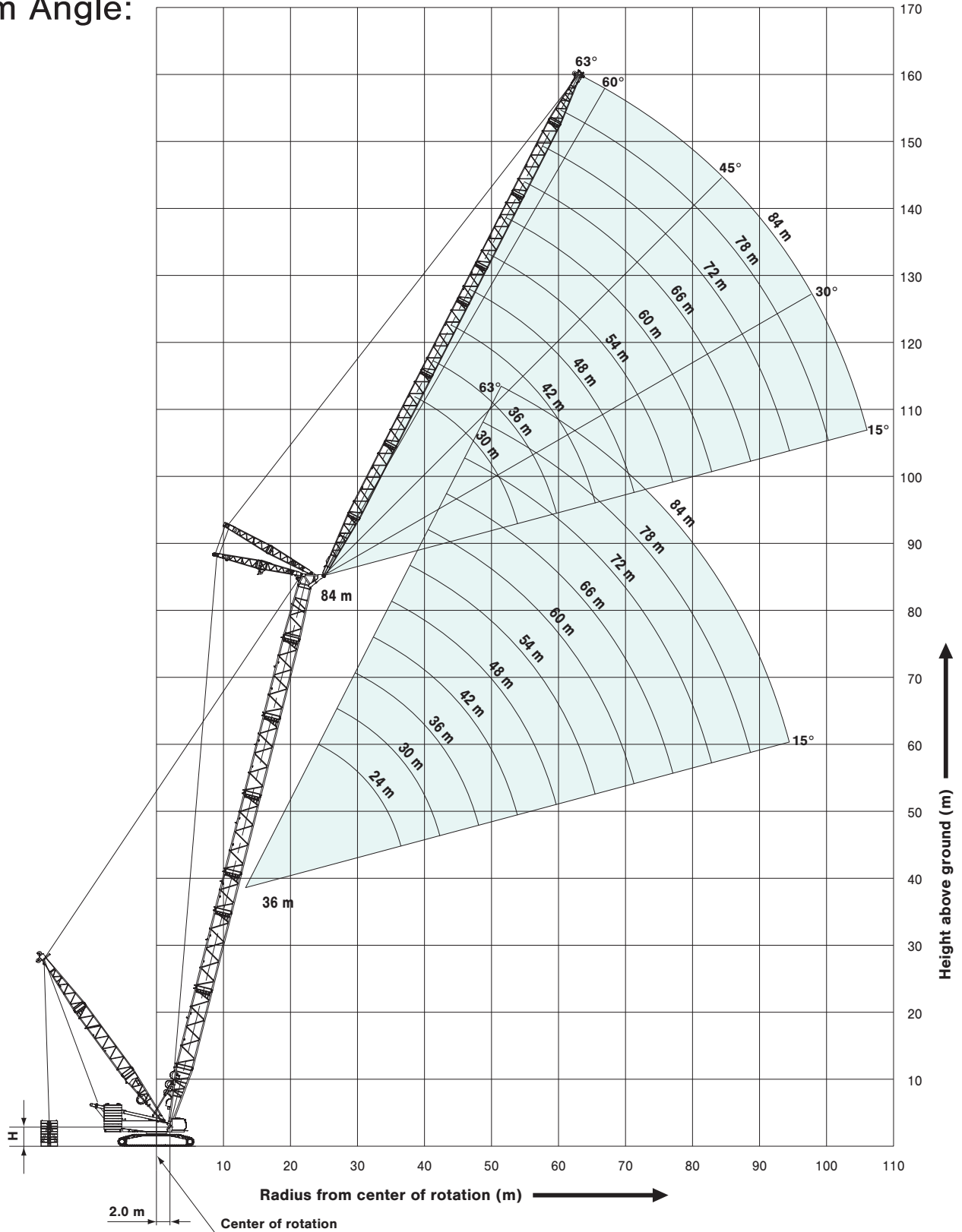

H=2.86 m Without quick connection ring  
H=3.08 m With quick connection ring

# Luffing Jib

Boom Angle:  
66°

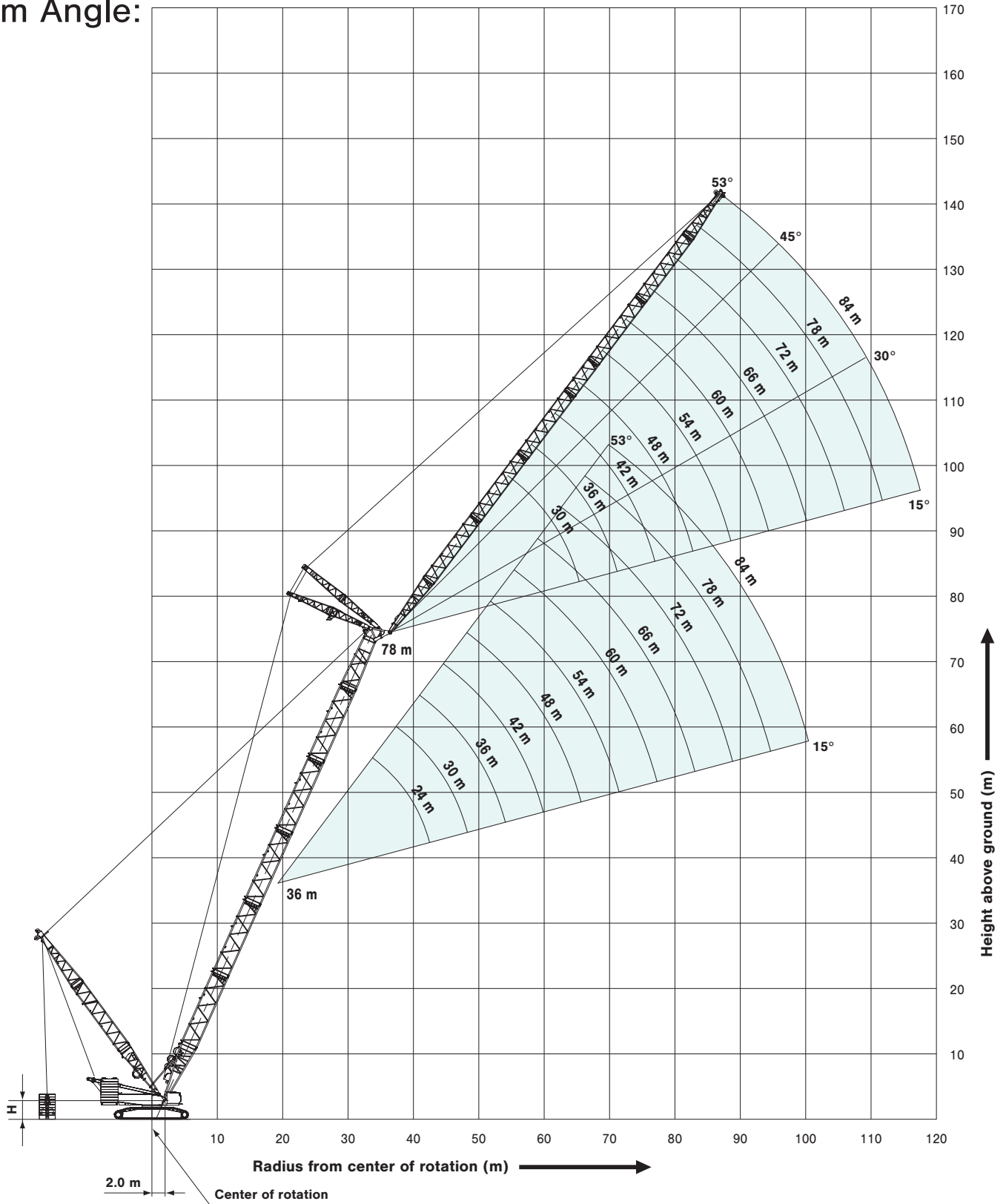

H=2.86 m Without quick connection ring  
H=3.08 m With quick connection ring

# SUPER HEAVY LIFT



## LIFTING CAPACITIES

### Heavy Duty Crane Boom Lifting Capacities

Unit: ton

Counterweight: 200.0 ton, Carbody weight: 50.0 ton  
Pallet weight: 250.0 ton

Boom Length (m) Load Radius (m)	36.0			42.0			48.0			54.0			60.0			Boom Length (m) Load Radius (m)
	Palette weight			Palette weight			Palette weight			Palette weight			Palette weight			
	11 m	13 m	16m	11 m	13 m	16m	11 m	13 m	16m	11 m	13 m	16m	11 m	13 m	16m	
8.0	8.3 m/550.0	8.3 m/550.0	8.3 m/550.0													8.0
9.0	548.9	548.8	548.7	9.2 m/547.9	9.2 m/547.6	9.2 m/547.3										9.0
10.0	528.0	547.0	547.0	526.8	547.6	547.3	10.0 m/450.0	10.0 m/450.0	10.0 m/450.0	10.9 m/370.0	10.9 m/370.0	10.9 m/370.0	11.7 m/336.0	11.7 m/336.0	11.7 m/336.0	10.0
12.0	442.2	476.2	524.5	441.1	475.1	524.5	440.2	450.0	450.0	370.0	370.0	370.0	336.0	336.0	336.0	12.0
14.0	379.8	409.2	449.6	378.7	408.1	449.6	377.9	407.3	449.6	370.0	370.0	370.0	336.0	336.0	336.0	14.0
16.0	332.4	358.3	393.4	331.4	357.2	393.4	330.6	356.4	393.4	329.3	355.2	370.0	328.3	336.0	336.0	16.0
18.0	295.2	318.3	349.7	294.2	317.3	349.7	293.4	316.5	349.7	292.2	315.3	349.6	291.2	314.3	336.0	18.0
20.0	265.2	286.0	314.7	264.2	285.1	314.7	263.5	284.3	314.7	262.2	283.1	314.1	261.2	282.1	313.1	20.0
22.0	240.5	259.5	286.1	239.5	258.5	286.1	238.8	257.8	286.1	237.6	256.6	284.9	236.6	255.6	283.9	22.0
24.0	219.2	237.3	262.2	218.9	236.3	262.2	218.1	235.6	261.6	216.9	234.4	260.4	215.9	233.4	259.4	24.0
26.0	199.4	218.4	236.2	199.4	217.4	241.5	199.3	216.7	240.7	199.0	215.5	239.6	198.4	214.5	238.6	26.0
28.0	182.5	200.1	209.8	182.5	200.0	223.5	182.4	199.8	222.8	182.0	199.3	221.7	181.4	198.3	220.7	28.0
30.0	168.1	181.5	186.1	168.1	184.3	206.8	167.9	184.1	206.5	167.5	183.6	205.9	166.8	182.9	205.1	30.0
32.0	153.0	164.5	164.3	155.5	170.7	190.1	155.4	170.5	191.4	154.9	170.0	190.8	154.2	169.2	190.0	32.0
34.0	33.8 m/139.9	33.8 m/150.4	33.8 m/145.2	144.6	158.8	171.6	144.4	158.6	178.2	143.9	158.1	177.6	143.2	157.3	176.7	34.0
36.0				134.8	148.2	154.4	134.7	148.0	166.5	134.2	147.5	165.9	133.4	146.7	165.1	36.0
38.0				126.2	136.3	138.2	126.0	138.7	156.1	125.6	138.1	155.6	124.8	137.3	154.7	38.0
40.0				39.0 m/121.2	39.0 m/130.4	39.0 m/129.9	118.3	130.3	143.8	117.8	129.8	146.3	117.0	128.9	145.4	40.0
44.0							105.0	115.3	118.1	104.5	115.4	130.3	103.8	114.5	129.4	44.0
48.0							44.2 m/104.4	44.2 m/114.4	44.2 m/116.7	93.5	103.4	111.7	92.8	102.6	116.3	48.0
52.0										49.4 m/90.1	49.4 m/99.7	49.4 m/104.5	83.5	92.6	104.7	52.0
56.0													54.6 m/78.2	54.6 m/86.9	54.6 m/93.9	56.0
Reeves	44	44	44	44	44	44	36	36	36	28	28	28	24	24	24	Reeves

Boom Length (m) Load Radius (m)	66.0			72.0			78.0			84.0			Boom Length (m) Load Radius (m)
	Palette weight			Palette weight			Palette weight			Palette weight			
	11 m	13 m	16m	11 m	13 m	16m	11 m	13 m	16m	11 m	13 m	16m	
12.0	12.5 m/280.0	12.5 m/280.0	12.5 m/280.0	13.4 m/280.0	13.4 m/280.0	13.4 m/280.0							12.0
14.0	280.0	280.0	280.0	280.0	280.0	280.0	14.2 m/220.0	14.2 m/220.0	14.2 m/220.0	15.0 m/200.0	15.0 m/200.0	15.0 m/200.0	14.0
16.0	280.0	280.0	280.0	280.0	280.0	280.0	220.0	220.0	220.0	200.0	200.0	200.0	16.0
18.0	280.0	280.0	280.0	280.0	280.0	280.0	220.0	220.0	220.0	200.0	200.0	200.0	18.0
20.0	260.0	280.0	280.0	258.9	279.7	280.0	220.0	220.0	220.0	200.0	200.0	200.0	20.0
22.0	235.3	254.3	280.0	234.3	253.3	280.0	220.0	220.0	220.0	200.0	200.0	200.0	22.0
24.0	214.7	232.1	258.2	213.6	231.1	257.1	212.3	220.0	220.0	200.0	200.0	200.0	24.0
26.0	197.1	213.3	237.3	196.1	212.2	236.3	194.8	211.0	220.0	193.7	200.0	200.0	26.0
28.0	180.6	197.1	219.4	179.8	196.0	218.4	178.9	194.8	217.1	177.9	193.7	200.0	28.0
30.0	166.0	182.0	203.9	165.2	181.2	202.8	164.3	180.2	201.6	163.2	179.1	200.0	30.0
32.0	153.4	168.3	189.0	152.6	167.5	188.1	151.6	166.5	187.0	150.6	165.4	185.9	32.0
34.0	142.3	156.3	175.7	141.5	155.5	174.8	140.5	154.5	173.8	139.5	153.4	172.6	34.0
36.0	132.5	145.8	164.1	131.7	144.9	163.1	130.7	143.9	162.1	129.7	142.8	160.9	36.0
38.0	123.9	136.4	153.7	123.0	135.5	152.7	122.0	134.5	151.7	121.0	133.4	150.5	38.0
40.0	116.1	128.0	144.4	115.3	127.1	143.4	114.3	126.1	142.4	113.2	124.9	141.2	40.0
44.0	102.8	113.6	128.5	102.0	112.7	127.5	100.9	111.6	126.4	99.8	110.5	125.2	44.0
48.0	91.8	101.7	115.3	91.0	100.8	114.3	89.9	99.7	113.2	88.8	98.6	112.1	48.0
52.0	82.6	91.7	104.2	81.7	90.8	103.3	80.7	89.7	102.2	79.6	88.6	101.0	52.0
56.0	74.7	83.1	94.8	73.9	82.2	93.8	72.8	81.2	92.7	71.7	80.0	91.6	56.0
60.0	59.8 m/68.2	59.8 m/76.1	59.8 m/84.2	67.1	74.9	85.7	66.0	73.8	84.6	64.9	72.7	83.4	60.0
64.0				61.1	68.4	78.6	60.1	67.4	77.5	59.0	66.3	76.3	64.0
68.0				65.0 m/59.7	65.0 m/66.9	65.0 m/75.7	54.9	61.7	71.2	53.8	60.6	70.1	68.0
72.0							70.2 m/52.2	70.2 m/58.9	70.2 m/67.8	49.1	55.6	64.6	72.0
76.0										75.4 m/45.6	75.4 m/51.8	75.4 m/60.3	76.0
Reeves	20	20	20	20	20	20	16	16	16	16	16	16	Reeves

Note : Ratings according to EN13000.

Ratings shown in   are determined by the strength of the boom or other structural components.

Lifting capacities may vary depending on hook used or with / without auxiliary sheave.

Please refer rated chart in operator's cabin.

Please refer Page 21 for Crane Boom Supplemental Data.



# Long Boom Lifting Capacities

Unit: ton

Counterweight: 200.0 ton, Carbody weight: 50.0 ton  
Pallet weight: 250.0 ton x 11 m, 13 m, 16 m

Load Radius (m) \ Boom Length (m)	90.0	96.0	102.0	108.0	114.0	120.0	126.0	Boom Length (m) \ Load Radius (m)
14.0	15.0 m/98.0	15.8 m/98.0						14.0
16.0	98.0	98.0	16.7 m/84.0	17.5 m/84.0				16.0
18.0	98.0	98.0	84.0	84.0	18.3 m/80.0	19.2 m/70.0		18.0
20.0	98.0	98.0	84.0	84.0	79.4	70.0	20.0 m/60.0	20.0
22.0	98.0	98.0	84.0	84.0	78.7	70.0	59.3	22.0
24.0	98.0	98.0	84.0	84.0	78.0	69.3	58.5	24.0
26.0	98.0	97.7	84.0	83.9	77.3	68.7	57.8	26.0
28.0	98.0	93.1	84.0	80.1	76.6	68.0	57.0	28.0
30.0	98.0	89.0	84.0	76.6	75.9	67.3	53.8	30.0
32.0	96.3	84.2	84.0	73.2	75.2	66.0	51.1	32.0
34.0	92.7	79.8	84.0	69.9	72.2	63.0	48.4	34.0
36.0	89.2	74.9	81.1	66.4	69.3	60.2	45.7	36.0
38.0	86.0	69.8	77.3	62.9	66.5	57.8	43.4	38.0
40.0	83.4	65.0	74.8	60.1	63.7	55.1	41.9	40.0
44.0	75.9	55.7	68.2	54.8	58.8	50.3	39.4	44.0
48.0	69.2	48.1	63.0	51.3	53.4	47.2	37.0	48.0
52.0	64.2	43.8	58.4	47.6	50.3	44.5	34.7	52.0
56.0	59.6	40.7	54.2	44.6	47.7	42.3	32.7	56.0
60.0	55.4	38.1	50.1	41.8	45.1	40.2	31.0	60.0
64.0	52.4	36.0	47.1	38.9	42.7	38.4	29.6	64.0
68.0	50.2	34.5	45.0	36.5	40.9	36.9	28.4	68.0
72.0	48.1	33.3	42.8	34.6	39.2	35.6	27.4	72.0
76.0	46.3	32.2	41.0	33.0	37.6	34.3	26.5	76.0
80.0	44.2	31.4	38.9	31.2	36.1	33.3	25.8	80.0
84.0	80.1 m/44.2	30.8	37.9	30.3	35.1	32.4	25.1	84.0
88.0		85.3 m/30.6	36.9	29.3	34.3	31.7	24.6	88.0
92.0			90.5 m/36.2	28.5	33.6	31.1	23.9	92.0
96.0				95.7 m/28.0	32.9	30.5	23.5	96.0
100.0					30.9	30.1	22.9	100.0
104.0					100.9 m/30.4	28.2	22.3	104.0
108.0						106.1 m/27.2	22.0	108.0
112.0							111.3 m/21.8	112.0
<b>Reeves</b>	7	7	6	6	6	5	5	<b>Reeves</b>

Note : Ratings according to EN13000.

Ratings shown in   are determined by the strength of the boom or other structural components.

Lifting capacities may vary depending on hook used or with / without auxiliary sheave.

Please refer rated chart in operator's cabin.

Please refer Page 21 for Crane Boom Supplemental Data.



## LIFTING CAPACITIES

### Heavy Fixed Jib (Type B2)

#### Lifting Capacities

Heavy Lift Mast Point Radius: 11 m

Unit: ton

Counterweight: 200.0 ton  
Carbody weight: 50.0 ton  
Pallet weight: 10.0 ton x 11 m

Jib Length (m) Working Radius (m)	18.0			Jib Length (m) Working Radius (m)
	66.0	72.0	78.0	
20.0	120.0	120.0	120.0	20.0
22.0	116.4	114.0	108.6	22.0
24.0	103.1	102.2	97.7	24.0
26.0	92.0	91.1	88.3	26.0
28.0	82.7	81.7	80.1	28.0
30.0	74.6	73.6	72.6	30.0
34.0	61.6	60.6	59.4	34.0
38.0	51.5	50.4	49.2	38.0
42.0	43.5	42.3	41.1	42.0
46.0	36.9	35.7	34.4	46.0
50.0	31.4	30.2	28.9	50.0
54.0	26.8	25.6	24.2	54.0
58.0	22.8	21.6	20.3	58.0
62.0	19.4	18.2	16.8	62.0
66.0	16.5	15.2	13.8	66.0
70.0	13.9	12.6	11.2	70.0
74.0	11.6	10.3	8.9	74.0
Reeves	10	10	10	Reeves

Note :

Ratings according to EN13000.

Ratings shown in   are determined by the strength of the boom or other structural components.

Lifting capacities may vary depending on hook used or with / without auxiliary sheave.

Please refer rated chart in operator's cabin.

Ratings enclosed in gray-color box in the table require double-drum specifications.

Please refer Page 21 for Heavy Fixed Jib Supplemental Data.

### Heavy Fixed Jib (Type C)

#### Lifting Capacities

Unit: ton

Counterweight: 200.0 ton  
Carbody weight: 50.0 ton  
Pallet weight: 130.0 ton x 11 m

Jib Length (m) Working Radius (m)	18.0				Jib Length (m) Working Radius (m)
	84.0	90.0	96.0	102.0	
22.0	105.0				22.0
24.0	105.0	95.0	85.0		24.0
26.0	105.0	95.0	85.0	80.0	26.0
28.0	105.0	95.0	85.0	80.0	28.0
30.0	105.0	95.0	85.0	80.0	30.0
34.0	96.7	95.0	85.0	80.0	34.0
38.0	82.2	81.2	80.0	78.8	38.0
42.0	70.6	69.5	68.3	67.1	42.0
46.0	61.2	60.0	58.8	57.6	46.0
50.0	53.3	52.1	50.8	49.6	50.0
54.0	46.6	45.4	44.1	42.9	54.0
58.0	40.9	39.7	38.4	37.1	58.0
62.0	36.0	34.8	33.4	32.1	62.0
66.0	31.7	30.5	29.1	27.8	66.0
70.0	27.9	26.7	25.3	24.0	70.0
74.0	24.6	23.3	21.9	20.6	74.0
78.0	21.6	20.3	18.9	17.6	78.0
82.0	18.9	17.6	16.2	14.8	82.0
86.0	84.0 m/17.7	84.0 m/16.4	84.0 m/15.0	84.0 m/13.6	86.0
Reeves	8	8	8	8	Reeves

Note :

Ratings according to EN13000.

Ratings shown in   are determined by the strength of the boom or other structural components.

Ratings enclosed in gray-color box in the table require double-drum specifications.

Please refer Page 21 for Heavy Fixed Jib Supplemental Data.





Unit: ton

# Luffing Boom Lifting Capacities

**Counterweight: 180.0 ton, Carbody weight: 50.0 ton**  
**Pallet weight: 250.0 ton x 13 m**

Load Radius (m)	36.0			42.0			48.0			54.0			60.0			Boom Length (m)	Load Radius (m)
	Palette weight			Palette weight			Palette weight			Palette weight			Palette weight				
	11 m	13 m	16m	11 m	13 m	16m	11 m	13 m	16m	11 m	13 m	16m	11 m	13 m	16m		
8.0	8.5 m/300.0	8.5 m/300.0	8.5 m/300.0													8.0	
9.0	300.0	300.0	300.0	9.3 m/300.0	9.3 m/300.0	9.3 m/300.0										9.0	
10.0	300.0	300.0	300.0	300.0	300.0	300.0	10.2 m/300.0	10.2 m/300.0	10.2 m/300.0	11.0 m/280.0	11.0 m/280.0	11.0 m/280.0	11.8 m/280.0	11.8 m/280.0	11.8 m/280.0	10.0	
12.0	300.0	300.0	300.0	300.0	300.0	300.0	300.0	300.0	300.0	280.0	280.0	280.0	280.0	280.0	280.0	12.0	
14.0	300.0	300.0	300.0	300.0	300.0	300.0	300.0	300.0	300.0	280.0	280.0	280.0	280.0	280.0	280.0	14.0	
16.0	300.0	300.0	300.0	300.0	300.0	300.0	300.0	300.0	300.0	280.0	280.0	280.0	280.0	280.0	280.0	16.0	
18.0	283.9	300.0	300.0	282.9	300.0	300.0	281.9	300.0	300.0	280.0	280.0	280.0	279.7	280.0	280.0	18.0	
20.0	253.4	275.4	300.0	253.8	274.4	300.0	252.9	273.4	300.0	251.7	272.2	280.0	250.7	271.3	280.0	20.0	
22.0	226.0	248.1	277.5	226.3	248.3	276.6	226.3	247.7	275.6	225.8	246.5	274.4	225.6	245.6	273.5	22.0	
24.0	203.6	223.7	248.9	203.8	223.8	251.3	203.7	223.6	251.0	203.2	223.1	250.2	203.0	222.7	249.7	24.0	
26.0	185.0	202.5	223.0	185.1	203.4	228.6	184.9	203.2	228.3	184.4	202.6	227.5	184.1	202.2	227.1	26.0	
28.0	168.6	182.3	199.8	169.2	186.2	209.5	169.0	185.9	209.1	168.4	185.2	208.3	168.1	184.8	207.8	28.0	
30.0	152.2	164.7	177.0	155.6	171.4	193.0	155.4	171.1	192.6	154.8	170.4	191.9	154.4	170.0	191.3	30.0	
32.0	137.6	149.0	156.1	143.8	158.5	177.2	143.6	158.2	178.4	142.9	157.5	177.6	142.5	157.1	177.0	32.0	
34.0	33.9 m/124.8	33.9 m/135.1	33.9 m/136.8	133.5	147.1	161.9	133.2	147.0	165.9	132.6	146.3	165.1	132.1	145.8	164.5	34.0	
36.0				124.2	134.5	146.4	124.1	137.1	154.9	123.4	136.3	154.1	123.0	135.8	153.5	36.0	
38.0				113.6	123.0	130.7	116.0	128.2	145.1	115.3	127.5	144.3	114.8	127.0	143.7	38.0	
40.0				39.1 m/107.9	39.1 m/116.9	39.1 m/122.1	108.7	120.3	134.3	108.0	119.6	135.5	107.5	119.1	134.9	40.0	
44.0							95.5	103.6	111.0	95.5	106.0	120.4	95.0	105.5	119.9	44.0	
48.0							44.3 m/94.2	44.3 m/102.2	44.3 m/109.1	85.2	94.7	104.6	84.7	94.3	107.4	48.0	
52.0										49.5 m/81.7	49.5 m/89.7	49.5 m/97.3	76.0	84.8	96.9	52.0	
56.0													54.7 m/70.8	54.7 m/79.2	54.7 m/87.2	56.0	
Reeves	24	24	24	24	24	24	24	24	24	20	20	20	20	20	20	Reeves	

Load Radius (m)	66.0			72.0			78.0			84.0			Boom Length (m)	Load Radius (m)
	Palette weight			Palette weight			Palette weight			Palette weight				
	11 m	13 m	16m	11 m	13 m	16m	11 m	13 m	16m	11 m	13 m	16m		
12.0	12.7 m/280.0	12.7 m/280.0	12.7 m/280.0	13.5 m/252.0	13.5 m/252.0	13.5 m/252.0							12.0	
14.0	280.0	280.0	280.0	252.0	252.0	252.0	14.3 m/213.5	14.3 m/213.5	14.3 m/213.5	15.2 m/182.8	15.2 m/182.8	15.2 m/182.8	14.0	
16.0	280.0	280.0	280.0	252.0	252.0	252.0	213.5	213.5	213.5	182.8	182.8	182.8	16.0	
18.0	278.4	280.0	280.0	252.0	252.0	252.0	213.5	213.5	213.5	182.8	182.8	182.8	18.0	
20.0	249.4	269.9	280.0	248.1	252.0	252.0	213.5	213.5	213.5	182.8	182.8	182.8	20.0	
22.0	224.9	244.3	272.2	224.1	243.0	252.0	213.5	213.5	213.5	182.8	182.8	182.8	22.0	
24.0	202.2	221.9	248.4	201.4	221.0	247.1	200.8	213.5	213.5	182.8	182.8	182.8	24.0	
26.0	183.3	201.3	226.1	182.4	200.4	225.1	181.7	199.7	213.5	180.8	182.8	182.8	26.0	
28.0	167.2	184.0	206.8	166.3	183.0	205.8	165.7	182.3	205.0	164.7	181.2	182.8	28.0	
30.0	153.5	169.1	190.3	152.6	168.1	189.3	151.9	167.3	188.5	150.9	166.3	182.5	30.0	
32.0	141.6	156.1	176.0	140.7	155.1	175.0	140.0	154.4	174.2	138.9	153.3	173.0	32.0	
34.0	131.2	144.9	163.5	130.2	143.8	162.5	129.5	143.1	161.6	128.5	142.0	160.5	34.0	
36.0	122.0	134.9	152.5	121.1	133.9	151.4	120.3	133.1	150.6	119.2	132.0	149.4	36.0	
38.0	113.9	126.0	142.7	112.9	125.0	141.6	112.1	124.2	140.8	111.0	123.1	139.6	38.0	
40.0	106.6	118.1	133.9	105.6	117.1	132.8	104.8	116.3	132.0	103.7	115.1	130.8	40.0	
44.0	94.1	104.5	118.8	93.1	103.5	117.7	92.3	102.7	116.9	91.2	101.5	115.7	44.0	
48.0	83.8	93.3	106.4	82.7	92.2	105.3	81.9	91.4	104.4	80.8	90.3	103.3	48.0	
52.0	75.1	83.9	95.9	74.0	82.8	94.8	73.2	82.0	94.0	72.1	80.8	92.8	52.0	
56.0	67.6	75.8	87.0	66.6	74.7	85.9	65.8	73.9	85.1	64.7	72.8	83.9	56.0	
60.0	59.9 m/61.4	59.9 m/69.0	59.9 m/77.8	60.2	67.8	78.2	59.4	67.0	77.4	58.3	65.8	76.2	60.0	
64.0				54.6	61.7	71.5	53.8	60.9	70.7	52.7	59.8	69.5	64.0	
68.0				65.1 m/53.2	65.1 m/60.2	65.1 m/69.4	48.9	55.6	64.7	47.8	54.4	63.6	68.0	
72.0							70.3 m/46.4	70.3 m/52.8	70.3 m/61.7	43.4	49.7	58.3	72.0	
76.0										75.5 m/40.0	75.5 m/46.0	75.5 m/54.2	76.0	
Reeves	20	20	20	20	20	20	16	16	16	16	16	16	Reeves	

Note : Ratings according to EN13000.

Ratings shown in   are determined by the strength of the boom or other structural components.

This is rated for double drum.

Lifting capacities may vary depending on hook used or with / without auxiliary sheave.

Please refer rated chart in operator's cabin.

Ratings enclosed in gray color box in the table require double-drum specifications.

Please refer Page 21 for Crane Boom Supplemental Data.



## LIFTING CAPACITIES Luffing Jib Lifting Capacity

Unit: ton

Counterweight: 200.0 ton, Carbody weight: 50.0 ton  
Pallet weight: 130.0 ton x 16 m

36.0 m Boom Length	36.0																		Boom length (m)
	24.0			30.0			36.0			42.0			48.0			54.0			Jib length (m)
	Jib length (m)																		Boom angle
Working Radius (m)	Boom angle																		Reeves
14.4	200.0																		14.4
15.0	193.2																		15.0
16.0	182.2																		16.0
17.0	176.9			171.2															17.0
18.0	172.3			165.7			162.1												18.0
20.0	164.7			156.4			152.0			143.5									20.0
22.0	159.2			148.8			143.5			139.3			137.6						22.0
24.0	155.9			142.8			136.3			132.4			129.6				119.3		24.0
26.0	145.9	156.4		138.0			130.4			125.8			122.7				118.2		26.0
28.0	129.4	149.8		134.7	142.2		125.4			120.2			116.7				114.3		28.0
30.0	98.3	144.9		121.0	135.4		121.4			115.4			111.5				108.8		30.0
34.0		130.7		99.8	125.6		103.2	118.9		105.8	115.0		103.0				99.8		34.0
38.0			114.7		116.9	113.7	87.6	110.5		89.9	105.4		91.9	102.2			92.7		38.0
42.0			101.7		98.0	100.8		104.7	100.6	78.0	98.3		79.7	94.2			81.3	91.6	42.0
46.0						90.4		91.8	90.2	64.8	93.1	89.3	70.3	88.1			71.7	84.9	46.0
50.0									81.7		81.3	80.8	62.6	82.4	79.9	63.9	79.6		50.0
54.0									74.6			73.6		72.2	72.7	57.6	72.5	71.7	54.0
58.0												67.6		63.5	66.7	48.0	64.7	65.7	58.0
62.0															61.5		58.5	60.5	62.0
66.0																		56.1	66.0
70.0																		52.2	70.0
Reeves		16			16			12		12			12			12			Reeves

36.0 m Boom Length	36.0															Boom length (m)			
	60.0			66.0			72.0			78.0			84.0			Jib length (m)			
	Jib length (m)															Boom angle			
Working Radius (m)	Boom angle															Reeves			
26.0	100.9																		26.0
28.0	100.1			89.1															28.0
30.0	94.9			88.5			73.4												30.0
34.0	85.9			87.1			72.3			62.4			54.1						34.0
38.0	78.3			84.6			70.3			60.1			50.5						38.0
42.0	71.9	83.2		79.0			65.3			55.5			46.4						42.0
46.0	66.3	76.2		69.0	80.6		60.9			51.5			42.8						46.0
50.0	61.6	70.6		60.7	74.6		57.0	63.9		48.0	54.2		39.7						50.0
54.0	57.4	65.4		53.9	67.7		53.4	59.8		44.9	50.5		37.0	41.8					54.0
58.0	53.2	62.9	65.7	48.0	59.8		47.6	57.5		42.2	47.2		34.5	38.8					58.0
62.0	48.0	58.8	60.5	43.0	53.2	59.4	43.0	53.3		39.7	44.2		32.3	36.2					62.0
66.0		52.8	56.0	38.5	47.6	54.9	38.6	47.7	54.1	37.4	41.6		30.3	33.8					66.0
70.0		47.0	52.0	34.5	42.7	50.4	34.7	42.9	49.8	35.1	39.2	43.3	28.5	31.7					70.0
74.0			48.5		38.3	45.3	31.1	38.6	44.8	31.6	37.0	40.9	26.8	29.8	33.1				74.0
78.0						40.9		34.8	40.5	28.5	34.9	38.7	25.3	28.1	31.1				78.0
82.0						37.5		31.3	37.0	25.0	31.5	36.0	23.7	26.5	29.3				82.0
86.0									34.3		28.5	33.7	22.3	25.1	27.7				86.0
90.0												30.8		23.8	26.3				90.0
94.0												27.8		22.6	25.0				94.0
98.0															23.9				98.0
Reeves		8			8			8		8			8						Reeves

Note : Ratings according to EN13000.

Ratings shown in   are determined by the strength of the boom or other structural components.

Lifting capacities may vary depending on hook used or with / without auxiliary sheave.

Please refer rated chart in operator's cabin.

Ratings enclosed in gray color box in the table require duple-drum specifications.

Please refer Page 23 to 25 for Luffing Jib Supplemental Data.



Unit: ton

# Luffing Jib Lifting Capacity

Counterweight: 200.0 ton, Carbody weight: 50.0 ton  
Pallet weight: 130.0 ton x 16 m

42.0 m Boom Length	42.0																	Boom length (m)	
	24.0			30.0			36.0			42.0			48.0			54.0			Jib length (m)
	86°			76°			66°			86°			76°			66°			Boom angle
15.4	191.5																	15.4	
16.0	188.0																	16.0	
17.0	182.7			176.8														17.0	
18.0	178.1			171.3														18.0	
20.0	170.7			162.0			157.3											20.0	
22.0	165.5			154.5			148.7			145.1			133.1					22.0	
24.0	162.6			148.5			141.6			137.4			131.3			111.9		24.0	
26.0	149.7			144.0			135.7			130.8			127.5			110.6		26.0	
28.0	132.6	158.0		137.9			130.8			125.2			121.4			109.2		28.0	
30.0	112.9	148.1		123.6	143.5		127.0			120.4			116.2			107.4		30.0	
34.0		130.7		101.8	130.7		105.1	126.0		107.9			107.7			103.4		34.0	
38.0		116.9	112.4		116.7		89.0	116.7		91.5	111.7		93.5	108.5		95.3		38.0	
42.0			99.6		103.5	98.6	73.0	103.4		79.2	102.6		81.0	99.8		82.5	97.2	42.0	
46.0						88.4		92.8	88.3	69.4	91.9		71.1	91.1		72.5	90.0	46.0	
50.0						80.1			79.9		83.2	78.9	63.3	82.3		64.6	81.4	50.0	
54.0									72.8		73.9	71.9		75.0	71.0	58.2	74.0	54.0	
58.0												65.9		66.2	65.0	52.3	66.8	58.0	
62.0												60.9			60.0		59.2	62.0	
66.0															55.6		52.6	66.0	
70.0																	50.7	70.0	
74.0																	47.4	74.0	
Reeves		16			16			12			12			12			8	Reeves	

42.0 m Boom Length	42.0															Boom length (m)		
	60.0			66.0			72.0			78.0			84.0			Jib length (m)		
	86°			76°			66°			86°			76°			66°		
26.0	95.1																	26.0
28.0	94.2			82.4														28.0
30.0	93.1			81.7			69.6											30.0
34.0	86.6			80.0			68.4			59.3			51.5					34.0
38.0	78.9			77.9			66.9			58.2			50.7					38.0
42.0	72.3			75.4			65.1			55.8			46.6					42.0
46.0	66.7	78.4		69.8	84.6		61.1			51.8			43.0					46.0
50.0	61.9	72.5		61.3	79.1		57.2	65.3		48.2			39.8					50.0
54.0	57.6	68.3		54.3	69.4		53.7	62.4		45.0	51.6		37.2	42.8				54.0
58.0	53.8	62.7		48.4	61.3		48.0	58.6		42.2	48.2		34.7	39.8				58.0
62.0	48.4	58.0	59.0	43.3	54.9	57.8	43.0	55.2		39.7	45.1		32.5	37.1				62.0
66.0		54.4	54.5	38.8	49.0	53.4	38.6	49.5	52.6	37.4	42.3		30.4	34.7				66.0
70.0		49.4	50.6	34.8	43.9	49.5	34.7	44.4	48.7	34.2	39.9	44.8	28.6	32.6				70.0
74.0			47.2		39.4	46.1	31.4	40.0	45.3	30.9	37.7	42.2	26.9	30.6	34.3			74.0
78.0			44.2		35.3	43.0		36.1	42.2	28.5	35.7	39.8	25.3	28.8	32.2			78.0
82.0					39.1			32.5	38.8	25.1	32.6	37.8	23.6	27.2	30.3			82.0
86.0									35.1		29.5	34.5	22.4	25.7	28.6			86.0
90.0									31.8		26.5	31.3		24.3	27.1			90.0
94.0												28.4		23.1	25.7			94.0
98.0															24.4			98.0
102.0															23.3			102.0
Reeves		8			8			8			8			8				Reeves

Note : Ratings according to EN13000.

Ratings shown in   are determined by the strength of the boom or other structural components.

Lifting capacities may vary depending on hook used or with / without auxiliary sheave.

Please refer rated chart in operator's cabin.

Ratings enclosed in gray color box in the table require duple-drum specifications.

Please refer Page 23 to 25 for Luffing Jib Supplemental Data.

# SUPER HEAVY LIFT



## LIFTING CAPACITIES Luffing Jib Lifting Capacity

Unit: ton

Counterweight: 200.0 ton, Carbody weight: 50.0 ton  
Pallet weight: 130.0 ton x 16 m

48.0 m Boom Length		48.0																	48.0 m Boom Length			
		24.0			30.0			36.0			42.0			48.0			54.0					
		86°	76°	66°	86°	76°	66°	86°	76°	66°	86°	76°	66°	86°	76°	66°	86°	76°			66°	
Working Radius (m)	16.2	191.5																			16.2	
	17.0	187.3			181.3																	17.0
	18.0	182.6			175.8																	18.0
	20.0	175.2			166.3			161.5														20.0
	22.0	170.0			158.7			152.9			143.9											22.0
	24.0	167.3			152.8			145.7			140.9			121.6				105.2				24.0
	26.0	154.0			148.3			139.7			134.6			119.4				103.9				26.0
	28.0	135.9	158.7		141.3			134.9			128.9			116.9				102.4				28.0
	30.0	121.1	148.1		126.4			130.2			124.1			114.2				100.6				30.0
	34.0		130.7		103.8	130.7		107.1	130.7		109.9			108.1				96.5				34.0
	38.0		116.0			115.1		90.6	115.2		92.9	114.2		94.9				91.8				38.0
	42.0			97.5		102.1		77.8	102.1		80.3	101.2		82.1	100.3		83.7	99.3				42.0
	46.0			87.4			86.4		91.5		70.3	90.6		72.1	89.8		73.4	88.8				46.0
	50.0						78.1		82.8	78.0		81.9	77.0	64.1	81.1		65.4	80.1				50.0
	54.0									71.1		74.7	70.1	57.3	73.8	69.2	58.7	72.9				54.0
	58.0									65.2			64.3		67.7	63.3	52.7	66.7	62.3			58.0
	62.0												59.3		60.7	58.3		61.5	57.3			62.0
66.0															54.0		54.7	53.0			66.0	
70.0															50.3			49.2			70.0	
74.0																		45.9			74.0	
Reeves		16			16			12			12			12			8				Reeves	

48.0 m Boom Length		48.0															48.0 m Boom Length				
		60.0			66.0			72.0			78.0			84.0							
		86°	76°	66°	86°	76°	66°	86°	76°	66°	86°	76°	66°	86°	76°	66°					
Working Radius (m)	26.0	89.5																			26.0
	28.0	88.5			77.0																28.0
	30.0	87.4			76.2			66.3													30.0
	34.0	84.6			74.3			65.0			56.3			49.0							34.0
	38.0	79.4			72.1			63.4			55.1			48.2							38.0
	42.0	72.8			69.5			61.5			53.8			46.9							42.0
	46.0	67.1	80.8		66.6			59.5			52.0			43.2							46.0
	50.0	62.2	74.2		62.0	79.3		57.3	66.9		48.4			40.0							50.0
	54.0	57.9	68.5		54.8	72.0		53.9	62.4		45.2	52.8		37.1							54.0
	58.0	54.2	63.5		48.8	63.8		48.4	59.6		42.3	49.2		34.5	40.7						58.0
	62.0	48.8	59.3	57.4	43.6	56.5		43.3	56.3		39.8	46.0		32.3	37.8						62.0
	66.0		55.6	53.0	39.1	51.1	51.8	38.8	51.5		37.4	43.2		30.5	35.2						66.0
	70.0		50.6	49.2	35.0	45.9	48.0	34.9	46.1	47.2	34.4	40.6		28.7	32.9						70.0
	74.0		45.2	45.9		41.2	44.7	31.5	41.4	43.9	31.0	38.4	42.9	27.0	31.0						74.0
	78.0			42.9		36.9	41.7		37.3	40.9	28.0	36.3	40.0	25.0	29.1	33.3					78.0
	82.0			40.3			39.1		33.6	38.3	25.2	33.7	37.3	23.6	27.5	31.3					82.0
	86.0						36.7			35.9		30.5	34.9	22.4	26.0	29.5					86.0
90.0									33.6		27.5	32.8		24.6	27.9					90.0	
94.0														30.0	26.3					94.0	
98.0														27.2	25.0					98.0	
102.0															23.9					102.0	
Reeves		8			8			8			8			8							Reeves

Note : Ratings according to EN13000.

Ratings shown in   are determined by the strength of the boom or other structural components.

Lifting capacities may vary depending on hook used or with / without auxiliary sheave.

Please refer rated chart in operator's cabin.

Ratings enclosed in gray color box in the table require duple-drum specifications.

Please refer Page 23 to 25 for Luffing Jib Supplemental Data.



Unit: ton

# Luffing Jib Lifting Capacity

Counterweight: 200.0 ton, Carbody weight: 50.0 ton  
Pallet weight: 130.0 ton x 16 m

54.0 m Boom Length	54.0																	Boom length (m)	
	24.0			30.0			36.0			42.0			48.0			54.0			Jib length (m)
	86°	76°	66°	86°	76°	66°	86°	76°	66°	86°	76°	66°	86°	76°	66°	86°	76°	66°	Boom angle
Working Radius (m)	17.0	186.2																	17.0
	18.0	186.2		179.5															18.0
	20.0	178.5		169.8			157.2												20.0
	22.0	173.3		162.0			152.9			132.3									22.0
	24.0	170.4		155.9			147.8			129.2			112.4						24.0
	26.0	158.3		151.4			142.5			125.8			110.1			95.8			26.0
	28.0	139.4		145.0			137.0			121.9			107.6			94.2			28.0
	30.0	124.0	148.1	129.3			131.4			117.8			104.9			92.3			30.0
	34.0		130.7	105.8	130.0		109.0			109.6			98.8			88.1			34.0
	38.0		114.5		113.5		92.1	113.6		94.4	112.7		92.5			83.4			38.0
	42.0			95.1	100.6		79.0	100.7		81.4	99.7		83.3	98.8		78.6			42.0
	46.0			85.2	90.2	84.1		90.2		71.3	89.3		73.0	88.4		73.7	87.4		46.0
	50.0					76.0		81.6	76.0		80.7		64.8	79.8		66.2	78.9		50.0
	54.0					69.3			69.2		73.5	68.2	53.8	72.7		59.4	71.7		54.0
	58.0								63.4		67.5	62.5		66.6	61.5	51.9	65.6		58.0
	62.0													57.6	61.4	56.6	60.4	55.5	62.0
	66.0													53.3		52.4	55.9	51.3	66.0
	70.0														48.7			47.6	70.0
	74.0																	44.4	74.0
	78.0																	41.6	78.0
Reeves		16			12			12			12			12		8			Reeves

54.0 m Boom Length	54.0																	Boom length (m)	
	60.0			66.0			72.0			78.0			84.0			Jib length (m)			
	86°	76°	66°	86°	76°	66°	86°	76°	66°	86°	76°	66°	86°	76°	66°	Boom angle			
Working Radius (m)	28.0	82.1				72.0													28.0
	30.0	80.9				71.2			62.2										30.0
	34.0	78.1				69.3			60.8			52.8			46.4				34.0
	38.0	74.7				66.9			59.1			51.6			45.5				38.0
	42.0	71.1				64.2			57.2			50.1			44.5				42.0
	46.0	67.3	83.4			61.3			55.0			48.5			43.3				46.0
	50.0	62.5	76.3			58.3	75.1		52.7			46.8			40.1				50.0
	54.0	58.2	70.3			55.3	70.8		50.4	63.8		45.0	54.1		37.2				54.0
	58.0	54.4	65.1			49.2	64.7		48.0	59.6		42.4	50.3		34.6	41.6			58.0
	62.0	49.2	60.6			43.9	58.8		43.6	56.0		39.8	47.0		32.3	38.6			62.0
	66.0	39.4	56.0	51.4		39.3	52.3		39.1	51.8		37.5	44.0		30.2	36.0			66.0
	70.0		52.1	47.7		35.2	46.8	46.5	35.1	46.3		34.6	41.4		28.3	33.6			70.0
	74.0		47.0	44.4		42.3	43.2	43.2	31.6	42.3	42.4	31.2	39.1	41.4	26.5	31.6			74.0
	78.0			41.5		37.9	40.3		38.6	39.5	28.1	37.0	38.5	25.0	29.7	34.5			78.0
	82.0			38.9			37.7		34.8	36.9	25.3	34.9	35.9	23.6	28.0	32.3			82.0
	86.0						35.4		31.3	34.6		31.5	33.6	22.3	26.5	30.4			86.0
	90.0						33.3			32.5		28.5	31.5		25.0	28.6			90.0
	94.0									30.6				29.6		23.7	27.0		94.0
	98.0													28.0		21.9	25.6		98.0
	102.0														26.0		24.4		102.0
	106.0																23.2		106.0
Reeves		8				8			8			8			8				Reeves

Note : Ratings according to EN13000.

Ratings shown in   are determined by the strength of the boom or other structural components.

Lifting capacities may vary depending on hook used or with / without auxiliary sheave.

Please refer rated chart in operator's cabin.

Ratings enclosed in gray color box in the table require duple-drum specifications.

Please refer Page 23 to 25 for Luffing Jib Supplemental Data.



## LIFTING CAPACITIES Luffing Jib Lifting Capacity

Unit: ton

Counterweight: 200.0 ton, Carbody weight: 50.0 ton  
Pallet weight: 130.0 ton x 16 m

60.0 m Boom Length	60.0																		Boom length (m)
	24.0			30.0			36.0			42.0			48.0			54.0			Jib length (m)
	86° 76° 66°			86° 76° 66°			86° 76° 66°			86° 76° 66°			86° 76° 66°			86° 76° 66°			Boom angle
	Double Drum			Double Drum			Double Drum			Double Drum			Double Drum			Double Drum			
17.8	190.1																	17.8	
18.0	189.1			164.0														18.0	
20.0	181.2			164.0			144.3											20.0	
22.0	175.6			159.6			140.2			121.8								22.0	
24.0	163.8			152.9			135.6			118.9			103.9					24.0	
26.0	150.9			146.0			130.8			115.5			101.8			89.3		26.0	
28.0	139.6			139.2			125.7			111.9			99.3			87.7		28.0	
30.0	126.9			130.1			120.5			108.2			96.7			85.9		30.0	
34.0		129.1		107.8	128.1		110.6			100.5			91.0			81.8		34.0	
38.0		112.8			111.8		93.6	111.9		92.9			85.0			77.3		38.0	
42.0		99.9			99.0		80.2	99.1		82.7	98.1		79.2	97.2		72.7		42.0	
46.0			82.9		88.7			88.8		72.3	87.8		73.7	86.9		68.1	85.9	46.0	
50.0			74.9			73.8		80.3			79.4		65.6	78.5		63.8	77.5	50.0	
54.0						67.2			67.2		72.3		58.6	71.4		59.7	70.4	54.0	
58.0						61.7			61.6	66.3	60.5			65.4		53.5	64.4	58.0	
62.0									56.7			55.7		60.3	54.8		59.2	53.7	62.0
66.0												51.6			50.6		54.8	49.5	66.0
70.0															47.0		51.0	45.9	70.0
74.0															43.9			42.8	74.0
78.0																		40.0	78.0
Reeves		16			16			12			12			8			8		Reeves

60.0 m Boom Length	60.0																		Boom length (m)
	60.0			66.0			72.0			78.0			84.0			Jib length (m)			
	86° 76° 66°			86° 76° 66°			86° 76° 66°			86° 76° 66°			86° 76° 66°			Boom angle			
	Double Drum			Double Drum			Double Drum			Double Drum			Double Drum						
28.0	76.9																	28.0	
30.0	75.6			66.6														30.0	
34.0	72.8			64.5			56.2			49.8				43.6				34.0	
38.0	69.5			62.2			54.5			48.6				42.7				38.0	
42.0	66.0			59.6			52.6			47.1				41.6				42.0	
46.0	62.4			56.8			50.4			45.5				40.4				46.0	
50.0	58.8	77.8		53.9	70.3		48.2			43.8				39.1				50.0	
54.0	55.4	70.7		51.0	69.6		46.0	59.9		42.0				37.4				54.0	
58.0	52.1	64.7		48.3	63.6		43.7	59.6		40.1	51.5			34.7	42.7			58.0	
62.0	49.2	59.5		44.3	58.4		41.5	57.1		38.3	48.0			32.4	39.8			62.0	
66.0	44.2	55.0	49.8	39.6	53.9		39.4	53.1		36.6	44.9			30.2	37.1			66.0	
70.0		51.1	46.1	35.4	48.5	44.9	35.4	48.0		34.8	42.2			28.3	34.7			70.0	
74.0		47.6	42.9		43.4	41.7	31.8	43.0	40.8	31.3	39.8			26.5	32.5			74.0	
78.0			40.0		39.2	38.8	28.5	38.6	38.0	28.2	37.4	36.8		25.0	30.5			78.0	
82.0			37.5		35.2	36.3		35.9	35.5	25.4	34.9	34.5		23.6	28.7	32.9		82.0	
86.0			35.3			34.0		32.4	33.2		32.6	32.1		22.3	27.1	31.4		86.0	
90.0						32.0			31.1		29.5	30.2			25.6	29.3		90.0	
94.0									29.3		26.3	28.3			24.2	27.5		94.0	
98.0									27.7			26.7			22.5	25.8		98.0	
102.0												25.2				24.3		102.0	
106.0																22.9		106.0	
110.0																21.6		110.0	
Reeves		8			8			8			8			8				Reeves	

Note : Ratings according to EN13000.

Ratings shown in   are determined by the strength of the boom or other structural components.

Lifting capacities may vary depending on hook used or with / without auxiliary sheave.

Please refer rated chart in operator's cabin.

Ratings enclosed in gray color box in the table require double-drum specifications.

Please refer Page 23 to 25 for Luffing Jib Supplemental Data.



Unit: ton

# Luffing Jib Lifting Capacity

Counterweight: 200.0 ton, Carbody weight: 50.0 ton  
Pallet weight: 130.0 ton x 16 m

66.0 m Boom Length	66.0																		Boom length (m)
	24.0			30.0			36.0			42.0			48.0			54.0			Jib length (m)
	86° 76° 66° 86° 76° 66° 86° 76° 66° 86° 76° 66° 86° 76° 66° 86° 76° 66°																		Boom angle
18.5	164.0																		18.5
20.0	164.0			148.3			143.7												20.0
22.0	161.6			142.6			139.8			111.8									22.0
24.0	153.4			136.5			135.1			109.0			95.8						24.0
26.0	141.6			130.5			130.1			105.8			93.7			82.6			26.0
28.0	131.3			124.4			125.1			102.5			91.4		81.0				28.0
30.0	122.1			118.6			119.8			99.0			88.8		79.3				30.0
34.0		127.1		107.0			107.9			91.8			83.4		75.3				34.0
38.0		111.0		91.6	110.0		95.3	110.1		84.8			77.9		71.0				38.0
42.0		98.3			97.3		81.6	97.5		78.4	96.5		72.4		66.6				42.0
46.0					87.1			87.3		72.7	86.3		67.3	85.4	62.4	84.3			46.0
50.0			72.6			71.5		78.9			77.9		62.7	77.0	58.3	76.0			50.0
54.0			66.1			65.0		71.9	65.0		70.9		58.9	70.0	54.6	69.0			54.0
58.0						59.6			59.6		65.0	58.5		64.1		51.4	63.1		58.0
62.0									54.8			53.8		59.0	52.8		58.0		62.0
66.0									50.8			49.8		54.7	48.8		53.6	47.7	66.0
70.0												46.2			45.3	49.8	44.1		70.0
74.0															42.2		41.1		74.0
78.0																	38.3		78.0
82.0																	36.0		82.0
Reeves		12			12			12			8			8		8			Reeves

66.0 m Boom Length	66.0															Boom length (m)			
	60.0			66.0			72.0			78.0			84.0			Jib length (m)			
	86° 76° 66° 86° 76° 66° 86° 76° 66° 86° 76° 66° 86° 76° 66°															Boom angle			
28.0	71.3															28.0			
30.0	70.1			61.8												30.0			
34.0	67.3			59.8			52.6			46.3						34.0			
38.0	64.1			57.5			50.9			45.1			39.4			38.0			
42.0	60.7			54.9			48.9			43.7			38.3			42.0			
46.0	57.3			52.2			46.8			42.1			37.1			46.0			
50.0	53.9	75.7		49.5			44.7			40.4			35.8			50.0			
54.0	50.6	69.4		46.7	65.4		42.5	56.3		38.6			34.4			54.0			
58.0	47.6	63.5		44.1	62.3		40.3	56.1	36.8	48.7			33.0			58.0			
62.0	44.9	58.3		41.7	57.2		38.2	55.4	35.1	48.5			31.5	40.5		62.0			
66.0	42.6	53.9		39.4	52.8		36.2	52.0	33.4	45.8			30.1	37.6		66.0			
70.0		50.0	44.4	35.7	48.9		34.4	48.1	31.7	42.9			28.3	35.1		70.0			
74.0		46.6	41.3		45.0	40.0	32.0	44.6		30.2	40.3			26.6	32.9		74.0		
78.0		43.6	38.5		40.4	37.2	28.7	40.0	36.1	28.4	38.0			25.0	30.9		78.0		
82.0			36.0		36.2	34.8		36.1	33.9	25.5	35.4	32.1		23.5	29.1		82.0		
86.0			33.8			32.5		32.5	31.7		32.0	30.7		22.3	27.5	28.6		86.0	
90.0						30.6		30.1	29.7		29.5	28.7		20.3	25.9	27.9		90.0	
94.0						28.8			27.9		26.2	26.9			24.5	26.0		94.0	
98.0									26.3			25.3			22.8	24.3		98.0	
102.0												23.8				22.7		102.0	
106.0												22.4				21.3		106.0	
110.0																20.1		110.0	
Reeves		8			8			8			8			8					Reeves

Note : Ratings according to EN13000.

Ratings shown in    are determined by the strength of the boom or other structural components.

Lifting capacities may vary depending on hook used or with / without auxiliary sheave.

Please refer rated chart in operator's cabin.

Ratings enclosed in gray color box in the table require duple-drum specifications.

Please refer Page 23 to 25 for Luffing Jib Supplemental Data.



# SUPER HEAVY LIFT



## LIFTING CAPACITIES Luffing Jib Lifting Capacity

Unit: ton

Counterweight: 200.0 ton, Carbody weight: 50.0 ton  
Pallet weight: 130.0 ton x 16 m

72.0 m Boom Length	72.0																	Boom length (m)		
	24.0			30.0			36.0			42.0			48.0			54.0			Jib length (m)	
	86°			76°			66°			86°			76°			66°			Boom angle	
19.2	156.6																	19.2		
20.0	153.9			134.6														20.0		
22.0	145.9			129.6				115.3										22.0		
24.0	134.8			124.3				111.5			99.0			88.3				24.0		
26.0	124.8			118.9				107.6			96.2			86.4			76.3	26.0		
28.0	115.7			113.6				103.4			93.2			84.2			74.8	28.0		
30.0	107.3			108.5				99.3			90.0			81.8			73.2	30.0		
34.0		125.0		97.1				91.3			83.6			76.9			69.5	34.0		
38.0		109.1		84.8	109.1			84.0			77.4			71.8			65.6	38.0		
42.0		96.5			96.6			77.7	95.8		71.6	94.8		66.8			61.5	42.0		
46.0					86.5				85.7		66.6	84.7		62.2	83.8		57.6	46.0		
50.0			70.3		78.2				77.4		62.7	76.5		58.0	75.5		53.9	74.5	50.0	
54.0			63.9				63.8		70.5			69.5		54.5	68.6		50.5	67.6	54.0	
58.0							58.4				57.5		63.7		62.8		47.5	61.8	58.0	
62.0							53.7				52.9		58.7	51.8		57.8		56.8	62.0	
66.0											48.9			47.9		53.5	46.9	52.4	66.0	
70.0														44.4			43.4	48.7	42.3	70.0
74.0														41.5			40.4	45.4	39.3	74.0
78.0																	37.8		36.7	78.0
82.0																			34.3	82.0
86.0																			32.3	86.0
Reeves		12				12			12			8			8			8		Reeves

72.0 m Boom Length	72.0															Boom length (m)				
	60.0			66.0			72.0			78.0			84.0			Jib length (m)				
	86°			76°			66°			86°			76°			66°			Boom angle	
28.0	66.1																			28.0
30.0	64.9			57.4																30.0
34.0	62.2			55.5				48.8			43.4									34.0
38.0	59.2			53.2				47.1			42.2			36.5						38.0
42.0	56.1			50.8				45.3			40.8			35.4						42.0
46.0	52.9			48.3				43.3			39.2			34.3						46.0
50.0	49.8	70.2		45.7				41.2			37.6			33.0						50.0
54.0	46.8	68.1		43.1	60.8			39.2			35.9			31.7						54.0
58.0	44.0	62.2		40.7	60.1			37.2	52.2		34.2	45.7		30.3						58.0
62.0	41.5	57.2		38.5	56.0			35.2	51.5		32.6	45.5		29.0	38.8					62.0
66.0	39.4	52.8		36.4	51.6			33.4	50.5		31.0	45.0		27.6	38.4					66.0
70.0		48.9		34.6	47.8			31.7	47.0		29.4	43.8		26.3	35.8					70.0
74.0		45.6	39.5		44.4			30.1	43.6		28.0	41.1		25.1	33.7					74.0
78.0		42.6	36.9		41.4	35.2		28.8	40.7	34.0	26.7	38.7		24.0	31.6					78.0
82.0			34.5		37.5	33.2			37.3	32.4	25.6	36.5	30.1	22.9	29.7					82.0
86.0			32.3			31.1			33.6	30.2		33.0	29.2	22.0	28.0	26.5				86.0
90.0			30.4			29.1			30.2	28.3		29.8	27.2		26.4	26.1				90.0
94.0						27.4				26.5		26.9	25.3		24.8	24.3				94.0
98.0										24.9			23.6		23.1	22.6				98.0
102.0										23.4				22.1		21.5	21.1			102.0
106.0														20.8			19.7			106.0
110.0																	18.5			110.0
114.0																	17.4			114.0
Reeves		8				8			8			8			8					Reeves

Note : Ratings according to EN13000.

Ratings shown in   are determined by the strength of the boom or other structural components.

Lifting capacities may vary depending on hook used or with / without auxiliary sheave.

Please refer rated chart in operator's cabin.

Ratings enclosed in gray color box in the table require double-drum specifications.

Please refer Page 23 to 25 for Luffing Jib Supplemental Data.





Unit: ton

# Luffing Jib Lifting Capacity

Counterweight: 200.0 ton, Carbody weight: 50.0 ton  
Pallet weight: 130.0 ton x 16 m

78.0 m Boom Length		78.0																		78.0 m Boom Length	
		30.0			36.0			42.0			48.0			54.0			60.0				
		Jib length (m)			Jib length (m)			Jib length (m)			Jib length (m)			Jib length (m)			Jib length (m)				
Working Radius (m)		Boom angle																		Working Radius (m)	
		86°	76°	66°	86°	76°	66°	86°	76°	66°	86°	76°	66°	86°	76°	66°	86°	76°	66°	Boom angle	
20.6	120.6																				20.6
22.0	117.5				105.2																22.0
24.0	112.9				101.8			90.3													24.0
26.0	104.9				98.2			87.7			78.3										26.0
28.0	97.6				94.5			85.0			76.4			67.9			60.9				28.0
30.0	91.0				90.8			82.1			74.2			66.4			59.8				30.0
34.0	79.4				80.8			76.4			69.7			63.0			57.3				34.0
38.0	69.2	107.1			71.4			70.7			65.1			59.4			54.5				38.0
42.0		94.8			63.1	93.9		64.2			60.6			55.7			51.5				42.0
46.0		84.1				84.0		57.3	83.0		56.5	83.4		52.1			48.6				46.0
50.0		73.4				75.0		50.9	74.9		52.7	75.2	48.8	73.2			45.6				50.0
54.0						66.3			67.1		47.8	68.0		45.7	67.4		42.9	64.1			54.0
58.0				56.2		58.4			59.9			61.1		43.0	61.0		40.4	60.7			58.0
62.0				51.7				50.8		53.5	49.7		55.1		39.4	55.1		38.1	55.0		62.0
66.0								46.9			45.9		49.7	46.1		50.0		36.2	49.9		66.0
70.0								43.6			42.5		42.7		45.4	41.6		45.5			70.0
74.0										39.6			39.7		41.0	38.7		41.5	37.2		74.0
78.0													37.1			36.0		37.8	35.2		78.0
82.0													34.7			33.7			32.8		82.0
86.0																31.6			30.7		86.0
90.0																			28.9		90.0
94.0																			27.2		94.0
Reeves		12				8			8			8			8			8			Reeves

78.0 m Boom Length		78.0												78.0 m Boom Length	
		66.0			72.0			78.0			84.0				
		Jib length (m)			Jib length (m)			Jib length (m)			Jib length (m)				
Working Radius (m)		Boom angle												Working Radius (m)	
		86°	76°	66°	86°	76°	66°	86°	76°	66°	86°	76°	66°	Boom angle	
30.0	53.0														30.0
34.0	51.1				45.0			40.0							34.0
38.0	49.0				43.4			38.9				33.6			38.0
42.0	46.7				41.7			37.5				32.6			42.0
46.0	44.3				39.8			36.1				31.4			46.0
50.0	41.9				37.8			34.5				30.2			50.0
54.0	39.5	56.2			35.9			32.9				28.9			54.0
58.0	37.3	55.6			34.0	48.3		31.3				27.7			58.0
62.0	35.2	53.8			32.2	47.7		29.7	42.2			26.4	35.9		62.0
66.0	33.3	48.8			30.5	46.8		28.3	41.7			25.1	35.7		66.0
70.0	31.6	44.3			28.9	43.9		26.8	41.0			23.9	35.2		70.0
74.0		40.3			27.5	40.0		25.5	39.4			22.8	34.0		74.0
78.0		36.8	33.0		26.4	36.5		24.3	36.0			21.7	31.7		78.0
82.0		33.5	31.5			33.3	29.2	23.3	32.8			20.7	29.9		82.0
86.0		30.9	29.5			30.4	28.5		30.0	25.3		19.8	28.4		86.0
90.0			27.5			28.2	26.5		27.4	25.3		27.0	22.0		90.0
94.0			25.7				24.7		25.0	23.5		24.7	22.0		94.0
98.0			24.2				23.1		22.7	21.9		22.5	20.8		98.0
102.0							21.7			20.4		20.5	19.4		102.0
106.0							20.4			19.1			18.1		106.0
110.0										18.0			16.9		110.0
114.0													15.8		114.0
Reeves		8				8			8			8			Reeves

Note : Ratings according to EN13000.

Ratings shown in    are determined by the strength of the boom or other structural components.

Lifting capacities may vary depending on hook used or with / without auxiliary sheave.

Please refer rated chart in operator's cabin.

Ratings enclosed in gray color box in the table require double-drum specifications.

Please refer Page 23 to 25 for Luffing Jib Supplemental Data.

# SUPER HEAVY LIFT



## LIFTING CAPACITIES Luffing Jib Lifting Capacity

Unit: ton

Counterweight: 200.0 ton, Carbody weight: 50.0 ton  
Pallet weight: 130.0 ton x 16 m

84.0 m Boom Length	84.0																		84.0			
	30.0		36.0		42.0		48.0		54.0		60.0		66.0		72.0		78.0		84.0			
	86°		76°		86°		76°		86°		76°		86°		76°		86°		76°		86°	
21.4	104.6																				21.4	
22.0	101.9		96.1																			22.0
24.0	94.3		93.1		83.3																	24.0
26.0	87.4		87.8		81.0		71.5															26.0
28.0	81.3		81.8		78.6		69.8		62.4													28.0
30.0	75.8		76.4		76.0		67.9		61.0		54.5											30.0
34.0	66.0		67.0		67.2		63.8		58.0		52.2		45.8		41.4							34.0
38.0	57.5		59.1		59.6		59.6		54.6		49.6		43.8		39.9		36.5					38.0
42.0		83.4	52.2	83.7	53.0		53.2		51.3		46.9		41.7		38.3		34.1					42.0
46.0		72.4		73.1	47.2	73.0	47.6		47.5		44.2		39.6		36.5		32.8					46.0
50.0		63.1		64.2	41.9	64.4	42.7	64.2	42.8	63.7	41.6		37.4		34.7		31.3					50.0
54.0		54.7		56.7		57.1	38.3	57.1	38.6	56.7	38.5	56.2	35.4		33.0		29.9					54.0
58.0				50.0		50.9		51.0	34.7	50.7	34.9	50.4	33.4	49.3	31.2	44.4	28.4					58.0
62.0						45.4		45.8	31.1	45.6	31.6	45.3	30.4	44.2	29.6	43.6	27.0	38.5				62.0
66.0								41.1		41.1	28.5	40.9	27.5	40.9	27.1	39.2	25.6	38.0				66.0
70.0								36.8		37.1		37.0	24.8	38.4	24.5	37.2	24.0	34.7				70.0
74.0										33.4		33.5	22.2	36.0	22.2	35.2	21.7	33.1				74.0
78.0												30.4		33.5	19.9	33.0	19.6	31.6				78.0
82.0												27.4		29.6		30.6	17.6	29.8				82.0
86.0														25.6		27.1		27.8				86.0
90.0																23.7		24.8				90.0
94.0																20.0		21.8				94.0
98.0																	17.7					98.0
Reeves		8		8		8		8		8		8		8		8		8		8		Reeves

Note : Ratings according to EN13000.

Ratings shown in   are determined by the strength of the boom or other structural components.

Lifting capacities may vary depending on hook used or with / without auxiliary sheave.

Please refer rated chart in operator's cabin.

Ratings enclosed in gray color box in the table require duple-drum specifications.

Please refer Page 23 to 25 for Luffing Jib Supplemental Data.



# TRANSPORTATION PLAN

## Base Machine

### Base Machine (A)

With

- Upper/Lower connecting device
- Crane mast
- Mast raising cylinder

Without

- Carbody
- Lower translifter
- Upper translifter
- Aux. platform
- Boom foot pin removal cylinder
- Reeving winch

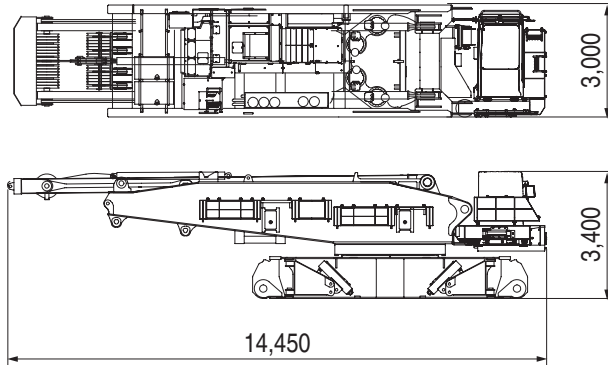

Weight	63,530 kg
Width	3.0 m
Height (Machine)	3.4 m
Length	14.45 m

### Base Machine (B)

With

- Upper/Lower connecting device
- Mast raising cylinder

Without

- Carbody
- Lower translifter
- Crane mast
- Upper translifter
- Aux. platform
- Boom foot pin removal cylinder
- Reeving winch

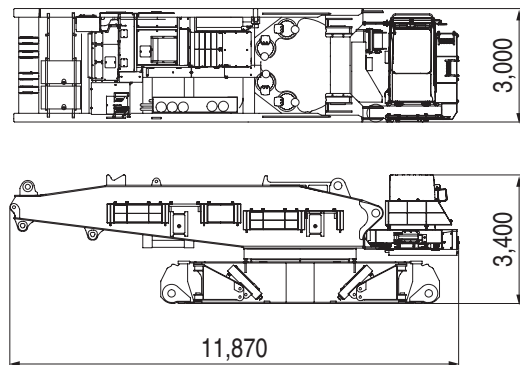

Weight	51,220 kg
Width	3.0 m
Height (Machine)	3.4 m
Length	11.87 m

### Base Machine (C)

With

- Carbody
- Mast raising cylinder

Without

- Upper/Lower connecting device
- Crane mast
- Upper translifter
- Lower translifter
- Aux. platform
- Boom foot pin removal cylinder
- Reeving winch

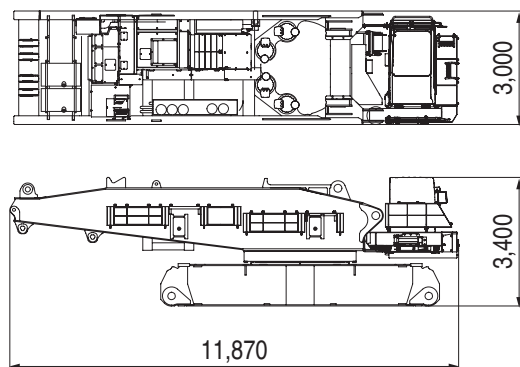

Weight	48,810 kg
Width	3.0 m
Height (Machine)	3.4 m
Length	11.87 m

## Upper Structure

### Upper Structure (A)

With

- Upper/Lower connecting device (Upper)
- Crane mast
- Mast raising cylinder

Without

- Upper transferter
- Lower transferter
- Aux. platform
- Boom foot pin removal cylinder
- Reeving winch
- Carbody

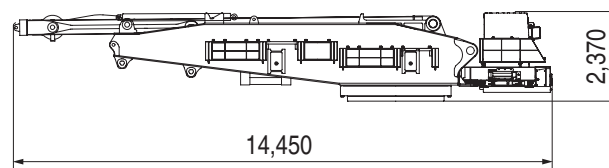
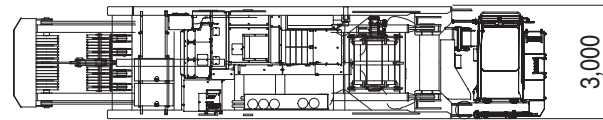

Weight	44,310 kg
Width	3.0 m
Height (Machine)	2.37 m
Length	14.45 m

### Upper Structure (B)

With

- Upper/Lower connecting device (Upper)
- Crane mast
- Mast raising cylinder
- Upper transferter

Without

- Aux. platform
- Boom foot pin removal cylinder
- Reeving winch
- Carbody
- Lower transferter

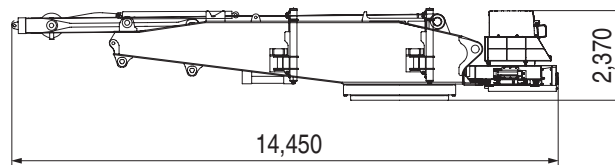
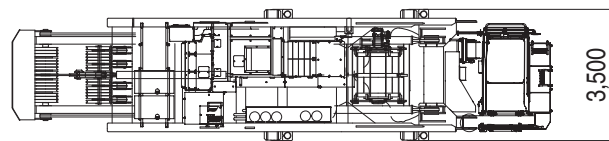

Weight	46,730 kg
Width	3.0 m
Height (Machine)	2.37 m
Length	14.45 m

### Upper Structure (C)

With

- Upper/Lower connecting device (Upper)
- Mast raising cylinder

Without

- Crane mast
- Upper transferter
- Aux. platform
- Boom foot pin removal cylinder
- Reeving winch
- Carbody
- Lower transferter

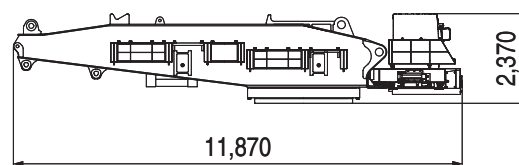
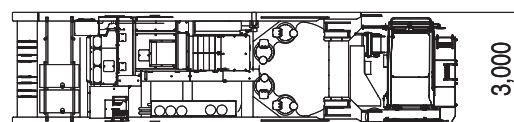

Weight	32,000 kg
Width	3.0 m
Height (Machine)	2.37 m
Length	11.87 m

# PARTS AND ATTACHMENTS

Dimensions: mm Weight: kg

## Base Machine (A)

With upper/lower connecting devices, crane mast, mast raising cylinder, Carbody, lower transfliter.  
Weight: 63,530 kg Width: 3,000 mm

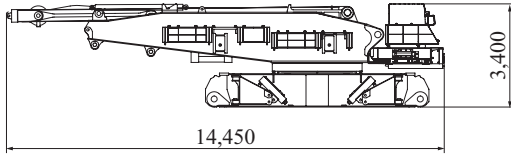

## Carbody

With upper/lower connecting devices.  
Weight: 22,610 kg Width: 2,990 mm

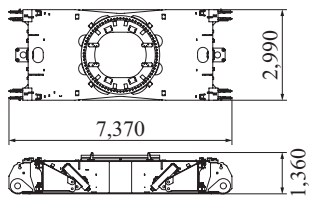

## Crawler

Weight: 40,000 kg Width: 1,910 mm

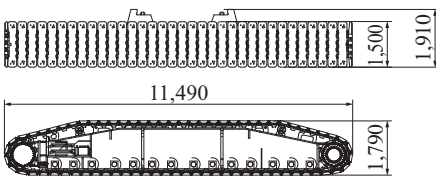

## Crane Mast

Weight: 12,940 kg

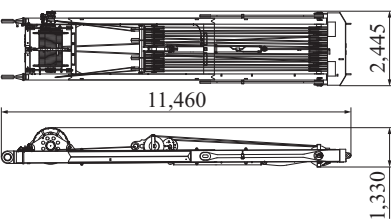

## 9 m Boom Base

With H1, H2 and W2 winches including ropes, guide sheave, and boom backstop  
Weight: 28,440 kg

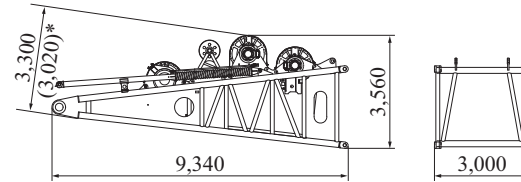

\* When the H1 drum winch is stowed.

## 6 m Boom Insert

With 6 m guy line (link) x 4  
Weight: 3,740 kg

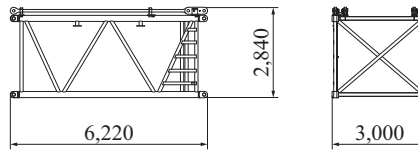

## 12 m Boom Insert

With 12 m guy line (link) x 4  
Weight: 6,740 kg

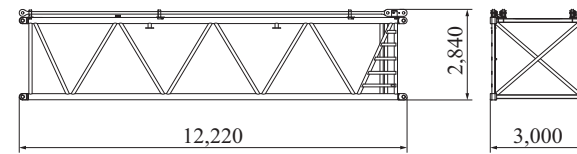

## 8 m Tapered Boom

With 8 m guy line (link) x 2  
Weight: 5,210 kg

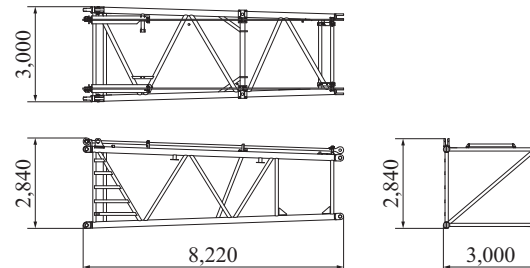

## Heavy Boom Tip

Weight: 4,910 kg

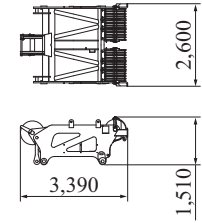

## Luffing Boom Tip

Weight: 5,520 kg

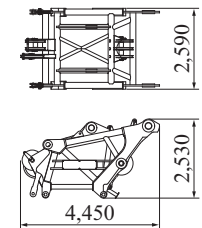

## Base Counterweight

Weight: 20,000 kg

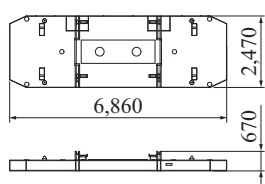

## Base Carbody Weight (5 t)

(with link)  
Weight: 5,400 kg

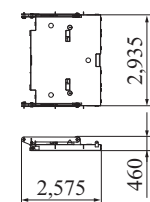

## Counterweight (L/R)

Carbody Weight (F/R)  
Weight: 10,000 kg

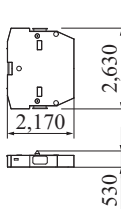

## Base Pallet Weight (10t) (with link)

Weight: 9,300 kg

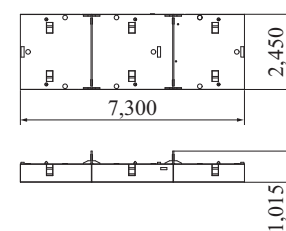

## Pallet Weight

Weight: 10,000 kg

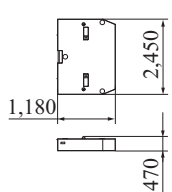

**9 m Mast Base**

Weight: 13,700 kg

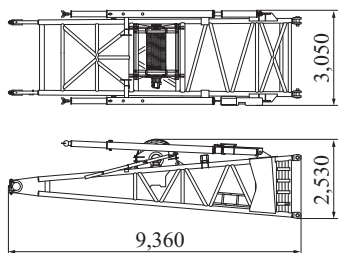

**12 m Mast Insert**

With guy line

Weight: 5,650 kg

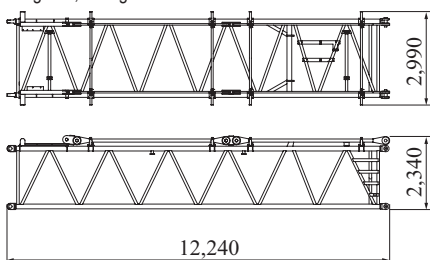

**9 m Mast tip**

With guy line

Weight: 10,080 kg

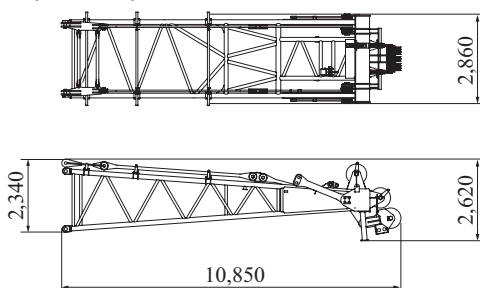

**Hanger sheave**

Weight: 2,010 kg

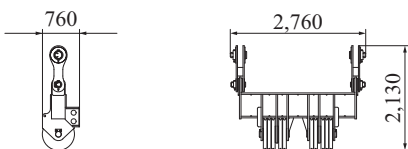

**550 t Hook**

Weight: 11,730 kg

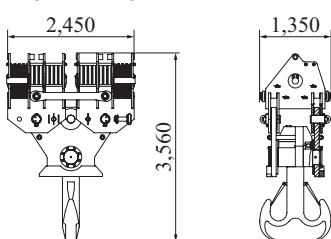

**300 t Hook**

Weight: 7,870 kg

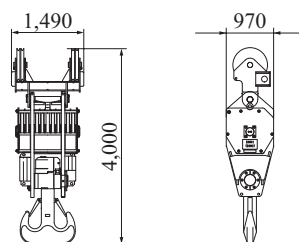

**200 t Hook**

Weight: 7,100 kg

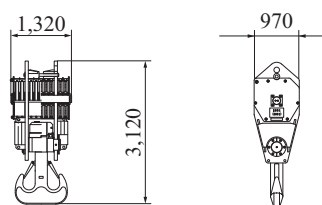

**120 t Hook**

Weight: 4,500 kg

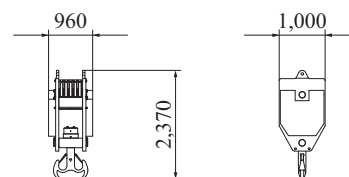

**70 t Hook**

Weight: 3,100 kg

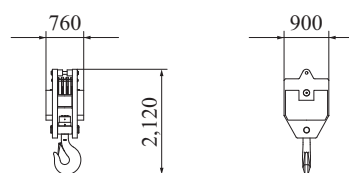

**40 t Hook**

Weight: 2,000 kg

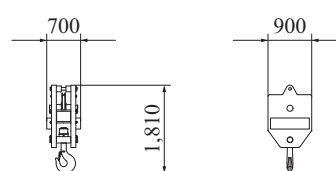

**Ball hook**

Weight: 830 kg

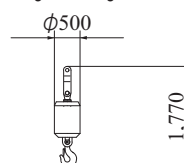

# PARTS AND ATTACHMENTS

Dimensions: mm Weight: kg

## 5 m boom insert for long boom

Weight: 1,790 kg

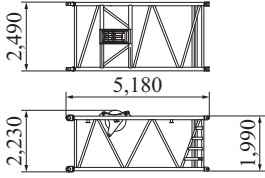

## 10 m Jib Base

Weight: 3,780 kg

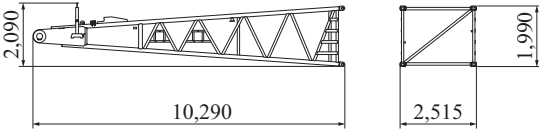

## 6 m Jib Insert

Weight: 1,470 kg

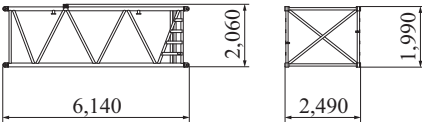

## 12 m Jib Insert

Weight: 2,680 kg

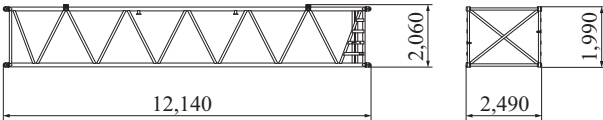

## 8 m Jib Tip

Weight: 3,690 kg

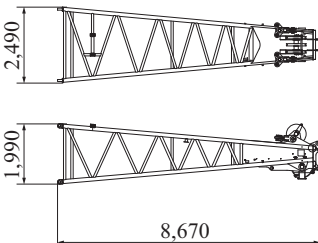

## Strut (For Heavy Fixed Jib)

With guy cable  
Weight: 1,510 kg

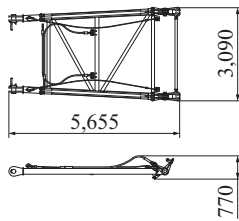

## Rear strut base

Weight: 1,990 kg

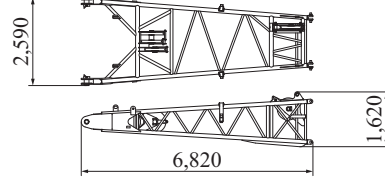

## Rear strut tip

Weight: 2,410 kg

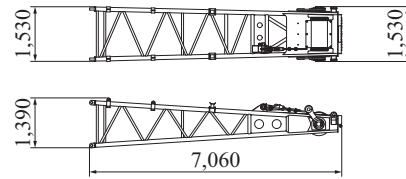

## Front strut base

Weight: 1,840 kg

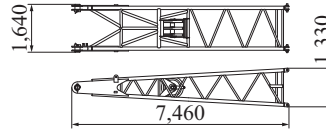

## Front strut tip

Weight: 3,040 kg

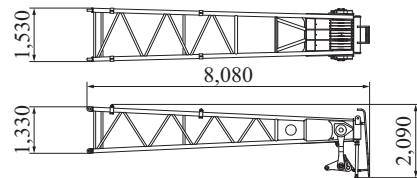

## Auxiliary sheave

Weight: 650 kg

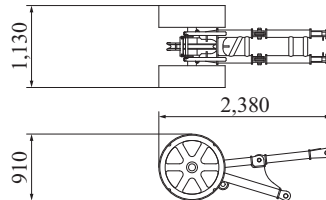











Note: This catalog may contain photographs of machines with specifications, attachments and optional equipment not certified for operation in your country. Please consult KOBELCO for those items you may require. Due to our policy of continual product improvements all designs and specifications are subject to change without advance notice.

Copyright by KOBELCO CONSTRUCTION MACHINERY CO., LTD. No part of this catalog may be reproduced in any manner without notice.

---

## **KOBELCO CONSTRUCTION MACHINERY CO., LTD.**

Inquiries To:

5-15, Kitashinagawa 5-chome, Shinagawa-ku, Tokyo 141-8626 JAPAN

Tel: +81-3-5789-2121 Fax: +81-3-5789-3372

URL: <https://www.kobelcocm-global.com>