

KOBELCO

SK300LC/SK300NLC-11E

Performance  Design

SK300_{LC} SK300_{NLC}

- Bucket capacity:
0.60 – 1.40 m³
- Engine power:
210 kW / 1,900 min⁻¹
- Operating weight:
30,600 – 33,900 kg



Complies with the EU Stage V
exhaust emission regulation

Built for Perfectionists™



Performance X Design

SK300LC/SK300NLC of KOBELCO has realised a completely new value by harmonising PERFORMANCE and DESIGN.

Performance enhancements offer greater efficiency and productivity along with increased power and speed. Design improvements provide the ultimate in comfort and control. KOBELCO refuses to compromise, creating machines that meet every challenge.



THE ULTIMATE IN SIMPLE DESIGN

In our pursuit of functional beauty and styling,
we created an all new interior design focused with the operator in mind.

Jog Dial

This dial integrates multiple functions into a single, easy to use interface.
Even with gloves on, the operator can make the adjustments they need.

LED Illumination

Dials and buttons are now backlit to provide a bright, clear view in any
lighting condition.







UNFORGETTABLE COMFORT

Air suspension seat

A GRAMMER* seat is installed as standard equipment, which achieves excellent shock absorption and superior ride comfort.

*GRAMMER is trademark of GRAMMER AG, registered in Germany and other countries.

Multi Vent Air Conditioner

Cool air is blown from multiple outlets toward the operator's body for more comfortable operation.

Ergonomic Lever Angles

Operators can move levers horizontally without twisting their wrists, reducing fatigue.



New Hydraulic Control

Our newly upgraded hydraulic control system responds to shorter lever strokes than previous models, delivering swifter, more precise movement and improved lever operability.

LED Interior Light

Interior lights turn on and off automatically when the door is open or the ignition is turned to the OFF position. This ensures safe entry and exit in the dark.

Parallel wipers secure a wide field of view



KOBELCO



04:33



SETTING MENU



PICTURE OF CAMERA



CLOCK SETTING



SCREEN BRIGHTNESS



MAINTENANCE



CONSUMPTION



LANGUAGE SELECTION



PRESSURE RELEASE



SAFETY ON FULL DISPLAY

Standard 3 Sides Safety Camera System

Our high-resolution, large display shows right, left and rear side cameras together. Multiple display allows the operator to customize viewing needs to enhance operator awareness and jobsite safety.

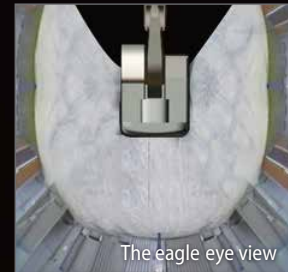
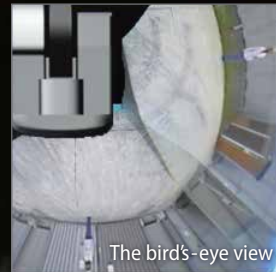
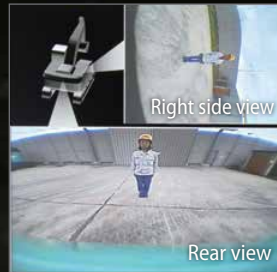
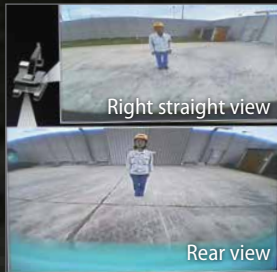

Large 10-Inch Color Monitor

The easy-to-operate menu screen and recognizable icons assist the operator to select the most important information needed to ensure jobsite safety and machine control.



Dial in the Right Information

Simply turn the jog dial to the right or left to select an operational feature, then press the dial to confirm selection.





Independent Travel

Selecting Independent Travel dedicates one hydraulic pump to travel and one to the attachment on a continuous basis, allowing for a smooth and constant movement speed even while swinging or using the boom or attachment. With Independent Travel, safely carrying a large pipe across a job site is a breeze.

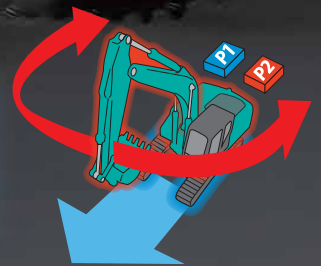

EXPERIENCING A COMPETENT PERFORMANCE

Excellent machine stability, plus a EU Stage V compliant engine

The new SK300LC/NLC is equipped with a Stage V compliant engine, which has a higher torque value. Superior balance between engine output and torque contributes to more efficient performance than the previous models. In addition, the DPF maintenance interval has been extended.

Model: ISUZU 6HK1

Engine output

210 kW / **1,900** min⁻¹



»» Max. bucket digging force (Arm 3.10 m)

Normal: **188** kN

With Power Boost: **208** kN

Lift capacity

16,150 kg

(Reach: 4.50 m Boom: 6.20 m Arm: 3.10 m Bucket: Without
Counterweight: 4,940 kg Shoe: 600 mm <Heavy Lift> At Ground Level)



GREATER MULTI-FUNCTION CAPABILITIES

Attachment mode selection

The auxiliary flow rates for the bucket, breaker, nibbler, and rotating are all now adjustable by the operator through the monitor, allowing you to change tools quickly and easily. Mode settings for other attachments like the tilt rotator can be added or changed.



EASY MAINTENANCE



Standard Overhead Top Guard Level II

The standard overhead cab guard can be tilted open with gas damper for easy window cleaning. Meets standard top guard level II requirements. (ISO 10262)



Engine Maintenance

Lower service platform makes engine service easier.



Two-stage air filter



DEF/AdBlue[®] Tank

The DEF/AdBlue[®] fill is located inside the locking tool box.



Left side (radiator and cooling system elements)

Laid out for easy access to radiator and cooling system.

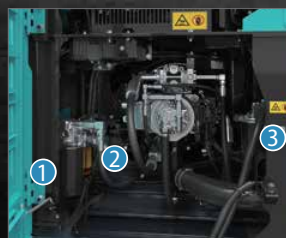

Right Side (Ground Level Maintenance)

Hydraulic pump and engine filter compartment.



1 Fuel Filter 2 Pre-Filter with Integrated Water Separator



3 Engine oil filter

Note: AdBlue[®] is a registered trademark of the Verband der Automobilindustrie e.V. (VDA).

DURABILITY YOU CAN TRUST

Enhanced body rigidity for 30-ton class machines

The SK300LC and SK300NLC machines are widely used in mid-scale construction projects and harsh worksites. The components have been reviewed and improvements have been made to their durability to ensure stable performance in such environments.



Panels and supports

The right and left side panels and rear supports have been thicker to enhance body rigidity.

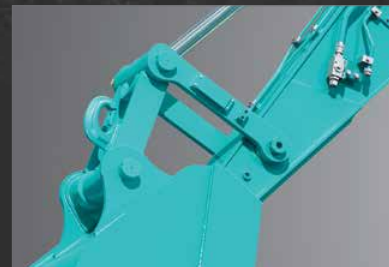

Bucket cylinder rod pin

The increased diameter of the bucket cylinder rod pin contributes to enhanced durability for various types of attachments.

CONVENIENT AND SENSIBLE EQUIPMENT



Engine start password

A password is required when starting the engine for greater security.



Wiper adjustment function

In addition to the intermittent wiper mode and continuous wiper mode, the one-time wiper mode was added.



Parallel wiper Sun screen (Option)



Console mount

The console-integrated seat allows for comfortable operation.



DAB+ radio (FM/AM & AUX & USB & Bluetooth® & hands-free telephone)



USB port/12V power outlet



Smartphone holder

You can use the holder with your smartphone connected to the USB port.

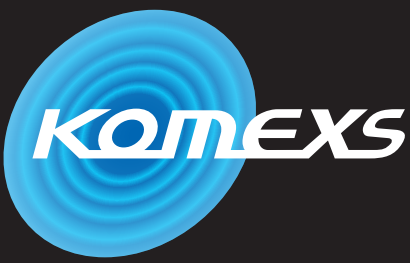

KOBELCO MONITORING EXCAVATOR SYSTEM



Remote Monitoring for Peace of Mind

KOMEXS (Kobelco Monitoring Excavator System) uses satellite communication and internet to relay data, and therefore can be deployed in areas where other forms of communication are difficult. When a hydraulic excavator is fitted with this system, data on the machine's operation, such as operating hours, location, fuel consumption, and maintenance status can be obtained remotely.

Direct Access to Operational Status

Location Data

Accurate location data can be obtained even from sites where communications are difficult.

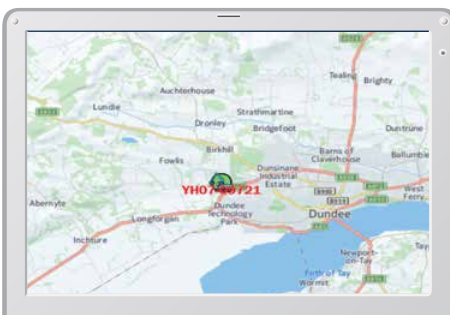

Latest location

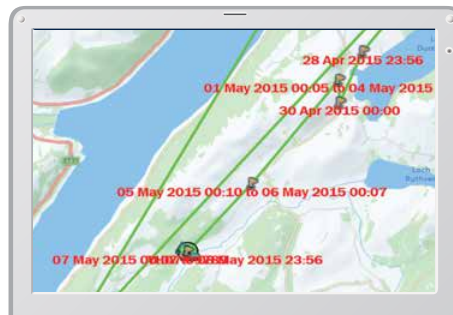

Location records

Period - 11 Apr, 2015		to 10 May, 2015		Search	
Type of Operation	Working Hrs		Ratio		
Total Working Hrs	169 Hrs	100%			
Digging Hrs	72.2 Hrs	43%			
Traveling Hrs	18.3 Hrs	11%			
Idle Hrs	15.9 Hrs	9%			
Opt Att Hrs	62.5 Hrs	37%			
Crane Mode Hrs	0 Hrs	0%			

Work data

Operating Hours

- A comparison of operating times of machines at multiple locations shows which locations are busier and more profitable.
- Operating hours on site can be accurately recorded, for running time calculations needed for rental machines, etc.

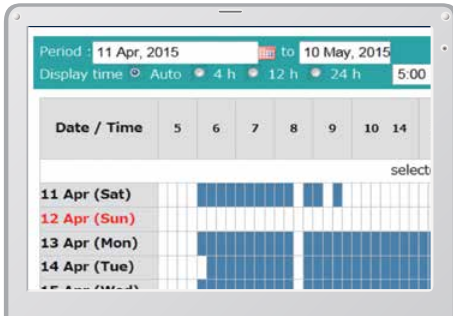

Daily report

Fuel Consumption Data

Data on fuel consumption and idling times can be used to indicate improvements in fuel consumption.

Work mode	Working Hrs	Total Fuel Consumption
H mode	2:06	24.5 L
S mode	0:00	0.0 L
E mode	169:19	1489.7 L
TOTAL	171:25	1514.2 L

Fuel consumption

Graph of Work Content

The graph shows how working hours are divided among different operating categories, including digging, idling, travelling and optional operations.

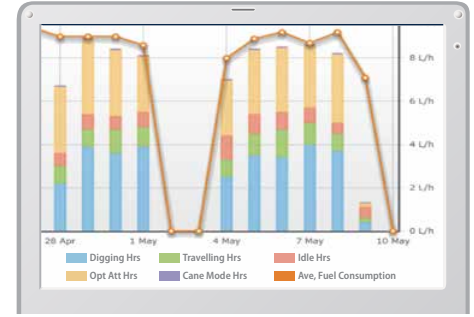

Work status

Maintenance Data and Warning Alerts

Machine Maintenance Data

- Provides maintenance status of separate machines operating at multiple sites.
- Maintenance data is also relayed to KOBELCO service personnel, for more efficient planning of periodic servicing.

Model	Serial No.	Hour Meter	Engine Oil
SK135SRLC-3/SK140SRL	YH07-09721	734 Hr	434
SK135SRLC-3/SK140SRL	YH07-09789	73 Hr	429
SK210LC-9	YQ13-10454	960 Hr	58
SK210LC-9	YQ13-10481	549 Hr	498
SK75SR-	YT08-30374		

Maintenance

Warning Alerts

This system warns an alert if an anomaly is sensed, preventing damage that could result in machine downtime.

Alarm Information Can Be Received through E-mail

Alarm information or maintenance notice can be received through E-mail, using a computer or cell phone.



Alarm messages can be received on mobile device.

Daily/Monthly Reports

Operational data downloaded onto a computer helps in formulating daily and monthly reports.

Security System

Engine Start Alarm

The system can be set an alarm if the machine is operated outside designated time.

Setting Condition Change
 Start time: 20 : 00
 Release time: 07 : 00
 No Working Whole Day
 Mon Tue Wed Thu Fri Sat Sun
 [] [] [] [] [] [] []
 Clear

Engine start alarm outside prescribed work time

Area Alarm

It can be set an alarm if the machine is moved out of its designated area to another location.

Setting Condition
 Around the current (latest) location 1 Km
 Input Latitude and Longitude
 Latitude1: []
 Longitude1: []
 Latitude2: []
 Longitude2: []
 Map Clear
 Release

Alarm for outside of reset area

Specifications

Engine

Model	ISUZU 6HK1
Type	Direct Injection, water-cooled, 4 cycle diesel engine with turbocharger, intercooler complies with EU stage V exhaust emission regulation
No. of cylinders	6
Bore and stroke	115 mm × 125 mm
Displacement	7,790 L
Rated power output	198 kW /1,900 min ⁻¹ (ISO 9249: with fan)
	210 kW /1,900 min ⁻¹ (ISO 14396: without fan)
Max. torque	1,011 N·m /1,500 min ⁻¹ (ISO 9249: with fan)
	1,080 N·m /1,500 min ⁻¹ (ISO 14396: without fan)

Hydraulic system

Pump	
Type	Axial piston pumps + extra gear pump + pilot gear pump
Max. discharge flow	2 × 245 L/min , 1 × 44.3 L/min , 1 × 19 L/min
Relief valve setting	
Boom, arm and bucket	34.3 MPa {350 kgf/cm ² }
Power Boost	37.8 MPa {385 kgf/cm ² }
Travel circuit	34.3 MPa {350 kgf/cm ² }
Swing circuit	29.0 MPa {296 kgf/cm ² }
Control circuit	5.0 MPa {51 kgf/cm ² }
Pilot control pump	Gear type
Main control valve	8 - Spool valve
Oil cooler	Air cooled type

Swing system

Swing motor	One fixed displacement piston motor
Brake	Oil disc brake, hydraulic operated automatically
Parking brake	Wet multiple plate
Swing speed	10.2 min ⁻¹
Swing Toruque	101 kNm

Attachments

Backhoe bucket and combination

Use	Backhoe bucket					
	Normal digging					
Bucket capacity	ISO heaped	m ³	0.60	0.80	1.20	1.40
Opening width		mm	800	1,000	1,420	1,400
Bucket weight		kg	620	720	950	930
Combination	2.40 m short arm		○	○	○	○
	3.10 m standard arm		○	○	○	△
	4.00 m long arm		○	△	△	△

○ Recommended △ Loading only

Travel system

Travel motors	2 × axial-piston, two-step motors
Travel brakes	Hydraulic brake per motor
Parking brakes	Oil disc brake per motors
Travel shoes	50 each side
Travel speed	5.2/3.1 km/h
Drawbar pulling force	279 kN (SAE)
Gradeability	70 % {35°}

Cab & control

Cab

All-weather, sound-suppressed steel cab mounted on the silicon-sealed viscous mounts and equipped with a heavy, insulated floor mat

Control

Two hand levers and two pedals for travel

Two hand levers for excavating and swing

Electric rotary-type engine throttle

Noise levels

External 106 dB(A) (2000/14/EC)

Operator 72 dB(A) (ISO 6396: 2008)

Vibration levels

Hand/arm* ≤ 2.5 m/s²

Body* ≤ 0.5 m/s²

*For the risk assessment according to 2002/44/EC, refer to ISO/TR 25398: 2006.

Boom, arm & bucket

Boom cylinders	140 mm x 1,305 mm
Arm cylinder	150 mm x 1,675 mm
Bucket cylinder	130 mm x 1,208 mm
Jib cylinder*	150 mm x 1,230 mm

*For 2 Piece Boom only

Refilling capacities & lubrications

Fuel tank	503L
Cooling system	41.4 L
Engine oil	48.6 L
Travel reduction gear	2 x 7.5 L
Swing reduction gear	1 x 7.4 L
Hydraulic oil tank	245 L tank oil level
	410 L hydraulic system
DEF/Urea tank	83 L

Working ranges

Unit: mm

Boom	6.20 m		
Range	Short 2.40 m	Standard 3.10 m	Long 4.00 m
a- Max. digging reach	10,230	10,860	11,710
b- Max. digging reach at ground level	10,020	10,670	11,540
c- Max. digging depth	6,500	7,200	8,100
d- Max. digging height	9,740	10,010	10,430
e- Max. dumping clearance	6,830	7,110	7,530
f- Min. dumping clearance	3,270	2,560	1,660
g- Max. vertical wall digging depth	5,600	6,170	7,020
h- Min. swing radius	4,400	4,430	4,550
i- Horizontal digging stroke at ground level	3,990	5,580	7,090
j- Digging depth for 2.4m(8') flat bottom	6,310	7,040	7,970
Bucket capacity ISO heaped m ³	1.40	1.20	1.00

Digging Force (ISO 6015)

Unit: kN

Arm length	Short 2.40 m	Standard 3.10 m	Long 4.00 m
Bucket digging force	188 208*	188 208*	188 208*
Arm crowding force	158 174*	126 139*	105 115*

*Power Boost engaged.

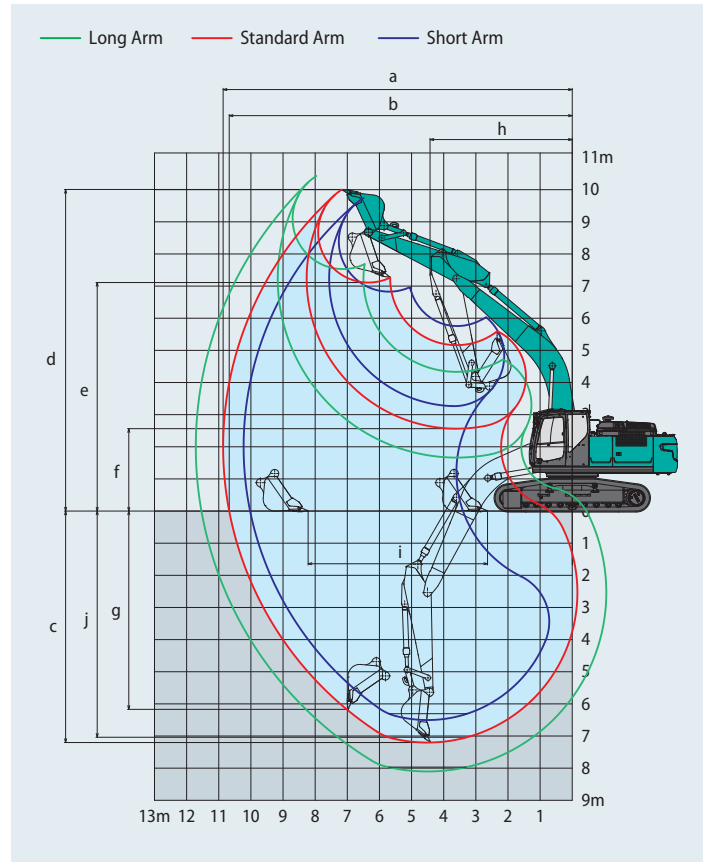

Dimensions

Arm length	Short 2.40 m	Standard 3.10 m	Long 4.00 m
A Overall length	10,830	10,710	10,770
B Overall height (to top of boom)	3,500	3,260	3,470
C Overall width of crawler	SK300LC	3,190	
	SK300NLC	2,990	
D Overall height (to top of cab)	3,200		
E Ground clearance of rear end*	1,200		
F Ground clearance*	490		

Unit: mm

G Tail swing radius	3,300	
G' Distance from centre of swing to rear end	3,270	
H Tumbler distance	4,000	
I Overall length of crawler	4,870	
J Track gauge	SK300LC	2,590
	SK300NLC	2,390
K Shoe width	600	
L Overall width of upperstructure	2,980	

*Without including height of shoe lug

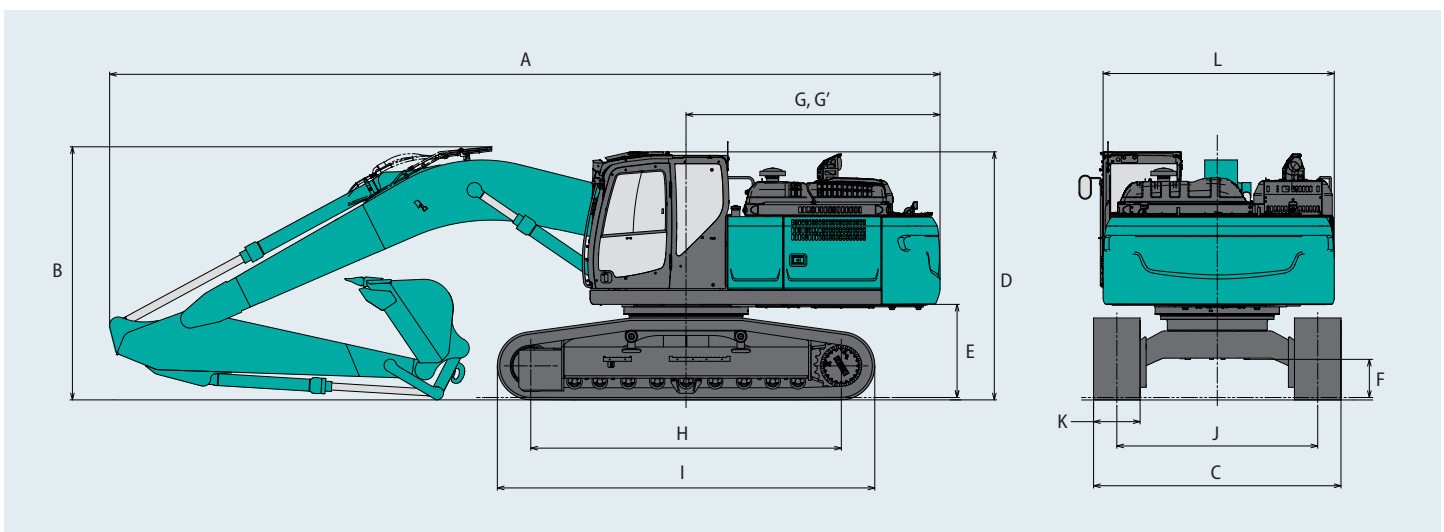

Operating weight & ground pressure

In standard trim, with standard boom, 3.10 m arm, and 1.20 m³ ISO heaped bucket, counterweight 4,940 kg

Shaped			Triple grouser shoes (even height)				Double grouser shoes
Shoe width	mm		600	700	800	900	600
Overall width of crawler	SK300LC	mm	3,190	3,290	3,390	3,490	3,190
	SK300NLC	mm	2,990	3,090	—	—	2,990
Ground pressure	SK300LC	kPa	58	51	45	41	58
	SK300NLC	kPa	58	51	—	—	58
Operating weight	SK300LC	kg	30,700	31,300	31,700	32,200	30,800
	SK300NLC	kg	30,700	31,300	—	—	30,800

In standard trim, with standard boom, 3.10 m arm, and 1.20 m³ ISO heaped bucket, counterweight 5,540 kg

Shaped			Triple grouser shoes (even height)				Double grouser shoes
Shoe width	mm		600	700	800	900	600
Overall width of crawler	SK300LC	mm	3,190	3,290	3,390	3,490	3,190
	SK300NLC	mm	2,990	3,090	—	—	2,990
Ground pressure	SK300LC	kPa	59	52	46	42	60
	SK300NLC	kPa	59	52	—	—	60
Operating weight	SK300LC	kg	31,300	31,900	32,300	32,800	31,400
	SK300NLC	kg	31,300	31,900	—	—	31,400

Lift capacities

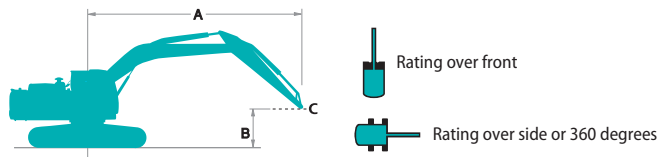

A - Reach from swing centerline to arm top
 B - Arm top height above/below ground
 C - Lift point
 Relief valve setting: 37.8 MPa {385 kgf/cm²}

SK300LC		Boom: 6.20 m Arm: 3.10 m Bucket: without Counterweight: 4,940 kg Shoe: 600 mm (Heavy Lift)															
B	A	1.5 m		3.0 m		4.5 m		6.0 m		7.5 m		9.0 m		At max. reach		Radius	
7.5 m	kg														*4,280	*4,280	7.45 m
6.0 m	kg														*4,070	*4,070	8.37 m
4.5 m	kg							*7,560	*7,560	*6,870	5,630				*4,030	*4,030	8.95 m
3.0 m	kg					*12,250	11,330	*9,060	7,470	*7,640	5,390	*6,290	4,070		*4,120	3,890	9.24 m
1.5 m	kg					*14,890	10,510	*10,500	7,040	8,310	5,160	6,330	3,960		*4,370	3,780	9.28 m
G.L.	kg					*16,150	10,150	11,350	6,770	8,120	4,990	*5,690	3,890		*4,800	3,850	9.06 m
-1.5 m	kg			*11,650	*11,650	*16,330	10,080	11,220	6,650	8,040	4,920				*5,550	4,140	8.57 m
-3.0 m	kg	*13,610	*13,610	*18,300	*18,300	*15,630	10,190	11,260	6,690	8,110	4,980				*6,970	4,780	7.76 m
-4.5 m	kg			*19,360	*19,360	*13,750	10,480	*10,120	6,920						*8,950	6,250	6.50 m

SK300LC		Boom: 6.20 m Arm: 4.00 m Bucket: without Counterweight: 4,940 kg Shoe: 600 mm (Heavy Lift)															
B	A	1.5 m		3.0 m		4.5 m		6.0 m		7.5 m		9.0 m		At max. reach		Radius	
9.0 m	kg														*3,360	*3,360	7.26 m
7.5 m	kg														*3,040	*3,040	8.49 m
6.0 m	kg									*5,240	*5,240	*4,300	4,230		*2,900	*2,900	9.31 m
4.5 m	kg									*5,830	5,650	*5,710	4,150		*2,870	*2,870	9.83 m
3.0 m	kg			*16,410	*16,410	*9,960	*9,960	*7,730	7,550	*6,680	5,360	*6,150	4,000		*2,920	*2,920	10.10 m
1.5 m	kg					*13,000	10,610	*9,330	7,010	*7,600	5,070	6,230	3,840		*3,070	*3,070	10.13 m
G.L.	kg			*7,360	*7,360	*14,990	9,960	*10,620	6,610	7,980	4,830	6,080	3,710		*3,330	3,210	9.93 m
-1.5 m	kg	*7,090	*7,090	*10,630	*10,630	*15,850	9,700	10,960	6,390	7,820	4,690	6,010	3,650		*3,770	3,400	9.49 m
-3.0 m	kg	*10,790	*10,790	*15,010	*15,010	*15,790	9,690	10,900	6,340	7,790	4,660				*4,520	3,810	8.77 m
-4.5 m	kg	*15,200	*15,200	*21,200	19,990	*14,740	9,890	*10,910	6,460	7,940	4,800				*6,040	4,670	7.68 m
-6.0 m	kg			*17,360	*17,360	*12,070	10,350	*8,400	6,860						*8,340	6,830	6.02 m

SK300LC		Boom: 6.20 m Arm: 2.40 m Bucket: without Counterweight: 4,940 kg Shoe: 600 mm (Heavy Lift)										
B	A	3.0 m		4.5 m		6.0 m		7.5 m		At max. reach		Radius
7.5 m	kg					*7,060	*7,060			*7,330	6,990	6.63 m
6.0 m	kg					*7,370	*7,370	*7,270	5,670	*7,240	5,460	7.66 m
4.5 m	kg			*10,620	*10,620	*8,450	7,780	*7,570	5,550	*7,150	4,710	8.28 m
3.0 m	kg					*9,860	7,330	*8,230	5,340	6,880	4,340	8.60 m
1.5 m	kg					*11,120	6,960	8,290	5,140	6,740	4,220	8.64 m
G.L.	kg			*16,450	10,150	11,330	6,760	8,150	5,020	6,940	4,330	8.41 m
-1.5 m	kg	*11,310	*11,310	*16,100	10,190	11,290	6,720	8,140	5,010	7,610	4,720	7.88 m
-3.0 m	kg	*20,440	*20,440	*14,920	10,380	*11,240	6,840			9,170	5,640	6.98 m
-4.5 m	kg			*12,190	10,790					*9,480	8,050	5.53 m

SK300LC		Boom: 6.20 m Arm: 3.10 m Bucket: without Counterweight: 5,540 kg Shoe: 600 mm (Heavy Lift)														
B	A	1.5 m		3.0 m		4.5 m		6.0 m		7.5 m		9.0 m		At max. reach		Radius
7.5 m	kg													*4,280	*4,280	7.45 m
6.0 m	kg									*6,370	6,050			*4,070	*4,070	8.37 m
4.5 m	kg							*7,560	*7,560	*6,870	5,870			*4,030	*4,030	8.95 m
3.0 m	kg					*12,250	11,820	*9,060	7,800	*7,640	5,640	*6,290	4,270	*4,120	4,090	9.24 m
1.5 m	kg					*14,890	11,000	*10,500	7,370	*8,450	5,410	6,590	4,160	*4,370	3,980	9.28 m
G.L.	kg					*16,150	10,640	*11,510	7,090	8,450	5,240	*5,690	4,090	*4,800	4,050	9.06 m
-1.5 m	kg			*11,650	*11,650	*16,330	10,570	11,660	6,980	8,370	5,170			*5,550	4,350	8.57 m
-3.0 m	kg	*13,610	*13,610	*18,300	*18,300	*15,630	10,680	*11,640	7,020	8,430	5,230			*6,970	5,020	7.76 m
-4.5 m	kg			*19,360	*19,360	*13,750	10,970	*10,120	7,250					*8,950	6,540	6.50 m

SK300LC		Boom: 6.20 m Arm: 4.00 m Bucket: without Counterweight: 5,540 kg Shoe: 600 mm (Heavy Lift)														
B	A	1.5 m		3.0 m		4.5 m		6.0 m		7.5 m		9.0 m		At max. reach		Radius
9.0 m	kg													*3,360	*3,360	7.26 m
7.5 m	kg													*3,040	*3,040	8.49 m
6.0 m	kg									*5,240	*5,240	*4,300	*4,300	*2,900	*2,900	9.31 m
4.5 m	kg									*5,830	*5,830	*5,710	4,350	*2,870	*2,870	9.83 m
3.0 m	kg			*16,410	*16,410	*9,960	*9,960	*7,730	*7,730	*6,680	5,610	*6,150	4,200	*2,920	*2,920	10.10 m
1.5 m	kg					*13,000	11,100	*9,330	7,340	*7,600	5,320	6,480	4,040	*3,070	*3,070	10.13 m
G.L.	kg			*7,360	*7,360	*14,990	10,450	*10,620	6,940	8,300	5,080	6,340	3,910	*3,330	*3,330	9.93 m
-1.5 m	kg	*7,090	*7,090	*10,630	*10,630	*15,850	10,190	*11,400	6,720	8,140	4,930	6,260	3,840	*3,770	3,580	9.49 m
-3.0 m	kg	*10,790	*10,790	*15,010	*15,010	*15,790	10,180	11,340	6,670	8,110	4,910			*4,520	4,010	8.77 m
-4.5 m	kg	*15,200	*15,200	*21,200	20,950	*14,740	10,380	*10,910	6,790	*8,210	5,050			*6,040	4,910	7.68 m
-6.0 m	kg			*17,360	*17,360	*12,070	10,840	*8,400	7,190					*8,340	7,160	6.02 m















SK300LC		Boom: 6.20 m Arm: 2.40 m Bucket: without Counterweight: 5,540 kg Shoe: 600 mm (Heavy Lift)										
B	A	3.0 m		4.5 m		6.0 m		7.5 m		At max. reach		Radius
7.5 m	kg					*7,060	*7,060			*7,330	7,270	6.63 m
6.0 m	kg					*7,370	*7,370	*7,270	5,920	*7,240	5,700	7.66 m
4.5 m	kg			*10,620	*10,620	*8,450	8,110	*7,570	5,790	*7,150	4,930	8.28 m
3.0 m	kg					*9,860	7,660	*8,230	5,590	7,150	4,550	8.60 m
1.5 m	kg					*11,120	7,290	8,610	5,390	7,000	4,430	8.64 m
G.L.	kg			*16,450	10,640	11,780	7,090	8,470	5,270	7,220	4,540	8.41 m
-1.5 m	kg	*11,310	*11,310	*16,100	10,680	11,730	7,050	8,460	5,260	7,920	4,960	7.88 m
-3.0 m	kg	*20,440	*20,440	*14,920	10,870	*11,240	7,170			*9,220	5,910	6.98 m
-4.5 m	kg			*12,190	11,280					*9,480	8,420	5.53 m















Notes:











- Do not attempt to lift or hold any load that is greater than these lift capacities at their specified lift point radius and heights. Weight of all accessories must be deducted from the above lift capacities.
- Lift capacities are based on machine standing on level, firm, and uniform ground. User must make allowance for job conditions such as soft or uneven ground, out of level conditions, side loads, sudden stopping of loads, hazardous conditions, experience of personnel, etc.
- Arm top defined as lift point.
- The above lift capacities are in compliance with ISO 10567. They do not exceed 87% of hydraulic lift















- capacity or 75% of tipping load. Lift capacities marked with an asterisk (*) are limited by hydraulic capacity rather than tipping load.
- Operator should be fully acquainted with the Operator's and Maintenance Instructions before operating this machine. Rules for safe operation of equipment should be adhered to at all times.
- Lift capacities apply to only machine as originally manufactured and normally equipped by KOBELCO CONSTRUCTION MACHINERY CO., LTD.

Lift capacities

SK300NLC		Boom: 6.20 m Arm: 3.10 m Bucket: without Counterweight: 4,940 kg Shoe: 600 mm (Heavy Lift)															
B	A	1.5 m		3.0 m		4.5 m		6.0 m		7.5 m		9.0 m		At max. reach		Radius	
																	
7.5 m	kg														*4,280	*4,280	7.45 m
6.0 m	kg									*6,370	5,350				*4,070	*4,070	8.37 m
4.5 m	kg							*7,560	7,310	*6,870	5,180				*4,030	3,850	8.95 m
3.0 m	kg					*12,250	10,290	*9,060	6,840	*7,640	4,950	*6,290	3,730	*4,120	3,570		9.24 m
1.5 m	kg					*14,890	9,490	*10,500	6,420	8,340	4,720	6,360	3,630	*4,370	3,460		9.28 m
G.L.	kg					*16,150	9,140	11,390	6,150	8,160	4,550	*5,690	3,550	*4,800	3,520		9.06 m
-1.5 m	kg			*11,650	*11,650	*16,330	9,070	11,260	6,040	8,080	4,480			*5,550	3,780		8.57 m
-3.0 m	kg	*13,610	*13,610	*18,300	18,030	*15,630	9,180	11,310	6,080	8,140	4,540			*6,970	4,360		7.76 m
-4.5 m	kg			*19,360	18,550	*13,750	9,470	*10,120	6,310					*8,950	5,700		6.50 m

SK300NLC		Boom: 6.20 m Arm: 4.00 m Bucket: without Counterweight: 4,940 kg Shoe: 600 mm (Heavy Lift)															
B	A	1.5 m		3.0 m		4.5 m		6.0 m		7.5 m		9.0 m		At max. reach		Radius	
																	
9.0 m	kg														*3,360	*3,360	7.26 m
7.5 m	kg														*3,040	*3,040	8.49 m
6.0 m	kg									*5,240	*5,240	*4,300	3,890	*2,900	*2,900		9.31 m
4.5 m	kg									*5,830	5,200	*5,710	3,800	*2,870	*2,870		9.83 m
3.0 m	kg			*16,410	*16,410	*9,960	*9,960	*7,730	6,910	*6,680	4,920	*6,150	3,660	*2,920	*2,920		10.10 m
1.5 m	kg					*13,000	9,580	*9,330	6,390	*7,600	4,630	6,250	3,500	*3,070	2,890		10.13 m
G.L.	kg			*7,360	*7,360	*14,990	8,950	*10,620	6,000	8,010	4,390	6,110	3,370	*3,330	2,910		9.93 m
-1.5 m	kg	*7,090	*7,090	*10,630	*10,630	*15,850	8,700	11,000	5,780	7,850	4,250	6,040	3,310	*3,770	3,080		9.49 m
-3.0 m	kg	*10,790	*10,790	*15,010	*15,010	*15,790	8,690	10,950	5,730	7,820	4,220			*4,520	3,460		8.77 m
-4.5 m	kg	*15,200	*15,200	*21,200	17,510	*14,740	8,890	*10,910	5,850	7,980	4,360			*6,040	4,250		7.68 m
-6.0 m	kg			*17,360	*17,360	*12,070	9,330	*8,400	6,240					*8,340	6,210		6.02 m

SK300NLC		Boom: 6.20 m Arm: 2.40 m Bucket: without Counterweight: 4,940 kg Shoe: 600 mm (Heavy Lift)															
B	A	3.0 m		4.5 m		6.0 m		7.5 m		At max. reach		Radius					
																	
7.5 m	kg						*7,060	*7,060				*7,330	6,440				6.63 m
6.0 m	kg						*7,370	*7,370	*7,270	5,220		*7,240	5,020				7.66 m
4.5 m	kg				*10,620	*10,620	*8,450	7,150	*7,570	5,100		*7,150	4,330				8.28 m
3.0 m	kg						*9,860	6,710	*8,230	4,900		6,910	3,980				8.60 m
1.5 m	kg						*11,120	6,350	8,320	4,710		6,760	3,860				8.64 m
G.L.	kg				*16,450	9,150	11,380	6,150	8,180	4,590		6,970	3,960				8.41 m
-1.5 m	kg	*11,310	*11,310	*16,100		9,190	11,330	6,110	8,170	4,580		7,650	4,320				7.88 m
-3.0 m	kg	*20,440	18,470	*14,920		9,370	*11,240	6,230				9,200	5,150				6.98 m
-4.5 m	kg				*12,190	9,770						*9,480	7,340				5.53 m

SK300NLC		Boom: 6.20 m Arm: 3.10 m Bucket: without Counterweight: 5,540 kg Shoe: 600 mm (Heavy Lift)															
B	A	1.5 m		3.0 m		4.5 m		6.0 m		7.5 m		9.0 m		At max. reach		Radius	
																	
7.5 m	kg														*4,280	*4,280	7.45 m
6.0 m	kg									*6,370	5,580				*4,070	*4,070	8.37 m
4.5 m	kg							*7,560	*7,560	*6,870	5,410				*4,030	*4,030	8.95 m
3.0 m	kg					*12,250	10,740	*9,060	7,150	*7,640	5,180	*6,290	3,920	*4,120	3,750		9.24 m
1.5 m	kg					*14,890	9,940	*10,500	6,730	*8,450	4,950	6,570	3,810	*4,370	3,640		9.28 m
G.L.	kg					*16,150	9,590	*11,510	6,460	8,430	4,790	*5,690	3,740	*4,800	3,700		9.06 m
-1.5 m	kg			*11,650	*11,650	*16,330	9,520	11,640	6,350	8,350	4,720			*5,550	3,970		8.57 m
-3.0 m	kg	*13,610	*13,610	*18,300	*18,300	*15,630	9,630	*11,640	6,390	8,420	4,780			*6,970	4,580		7.76 m
-4.5 m	kg			*19,360	*19,360	*13,750	9,920	*10,120	6,610					*8,950	5,980		6.50 m

SK300NLC		Boom: 6.20 m Arm: 4.00 m Bucket: without Counterweight: 5,540 kg Shoe: 600 mm (Heavy Lift)														
B	A	1.5 m		3.0 m		4.5 m		6.0 m		7.5 m		9.0 m		At max. reach		Radius
9.0 m	kg													*3,360	*3,360	7.26 m
7.5 m	kg													*3,040	*3,040	8.49 m
6.0 m	kg									*5,240	*5,240	*4,300	4,070	*2,900	*2,900	9.31 m
4.5 m	kg									*5,830	5,430	*5,710	3,990	*2,870	*2,870	9.83 m
3.0 m	kg			*16,410	*16,410	*9,960	*9,960	*7,730	7,220	*6,680	5,150	*6,150	3,850	*2,920	*2,920	10.10 m
1.5 m	kg					*13,000	10,030	*9,330	6,690	*7,600	4,860	6,470	3,690	*3,070	3,050	10.13 m
G.L.	kg			*7,360	*7,360	*14,990	9,400	*10,620	6,300	8,280	4,620	6,320	3,560	*3,330	3,080	9.93 m
-1.5 m	kg	*7,090	*7,090	*10,630	*10,630	*15,850	9,150	11,380	6,090	8,120	4,480	6,250	3,490	*3,770	3,260	9.49 m
-3.0 m	kg	*10,790	*10,790	*15,010	*15,010	*15,790	9,150	11,320	6,040	8,090	4,460			*4,520	3,650	8.77 m
-4.5 m	kg	*15,200	*15,200	*21,200	18,370	*14,740	9,340	*10,910	6,150	*8,210	4,590			*6,040	4,470	7.68 m
-6.0 m	kg			*17,360	*17,360	*12,070	9,780	*8,400	6,550					*8,340	6,520	6.02 m

SK300NLC		Boom: 6.20 m Arm: 2.40 m Bucket: without Counterweight: 5,540 kg Shoe: 600 mm (Heavy Lift)										
B	A	3.0 m		4.5 m		6.0 m		7.5 m		At max. reach		Radius
7.5 m	kg					*7,060	*7,060			*7,330	6,710	6.63 m
6.0 m	kg					*7,370	*7,370	*7,270	5,450	*7,240	5,250	7.66 m
4.5 m	kg			*10,620	*10,620	*8,450	7,450	*7,570	5,330	*7,150	4,530	8.28 m
3.0 m	kg					*9,860	7,010	*8,230	5,130	7,140	4,180	8.60 m
1.5 m	kg					*11,120	6,650	8,590	4,940	6,990	4,060	8.64 m
G.L.	kg			*16,450	9,600	11,750	6,460	8,450	4,820	7,200	4,160	8.41 m
-1.5 m	kg	*11,310	*11,310	*16,100	9,640	11,710	6,420	8,440	4,810	7,900	4,530	7.88 m
-3.0 m	kg	*20,440	19,330	*14,920	9,820	*11,240	6,530			*9,220	5,410	6.98 m
-4.5 m	kg			*12,190	10,220					*9,480	7,680	5.53 m

Notes:

- Do not attempt to lift or hold any load that is greater than these lift capacities at their specified lift point radius and heights. Weight of all accessories must be deducted from the above lift capacities.
- Lift capacities are based on machine standing on level, firm, and uniform ground. User must make allowance for job conditions such as soft or uneven ground, out of level conditions, side loads, sudden stopping of loads, hazardous conditions, experience of personnel, etc.
- Arm top defined as lift point.
- The above lift capacities are in compliance with ISO 10567. They do not exceed 87% of hydraulic lift capacity or 75% of tipping load. Lift capacities marked with an asterisk (*) are limited by hydraulic capacity rather than tipping load.
- Operator should be fully acquainted with the Operator's and Maintenance Instructions before operating this machine. Rules for safe operation of equipment should be adhered to at all times.
- Lift capacities apply to only machine as originally manufactured and normally equipped by KOBELCO CONSTRUCTION MACHINERY CO., LTD.

2 Piece Boom Specifications



Working ranges

Unit: mm

Boom	Arm	2 Piece Boom		
		Short 2.40 m	Standard 3.10 m	Long 4.00 m
Range				
a- Max. digging reach		10,290	10,940	11,810
b- Max. digging reach at ground level		10,090	10,760	11,630
c- Max. digging depth		6,210	6,900	7,790
d- Max. digging height		11,220	11,690	12,340
e- Max. dumping clearance		8,130	8,600	9,250
f- Min. dumping clearance		990	290	620
g- Max. vertical wall digging depth		4,360	4,990	5,750
h- Min. swing radius		3,400	3,000	3,120
i- Horizontal digging stroke at ground level		6,150	7,470	9,200
j- Digging depth for 2.4m(8') flat bottom		6,100	6,800	7,700
Bucket capacity ISO heaped m ³		1.40	1.20	1.00

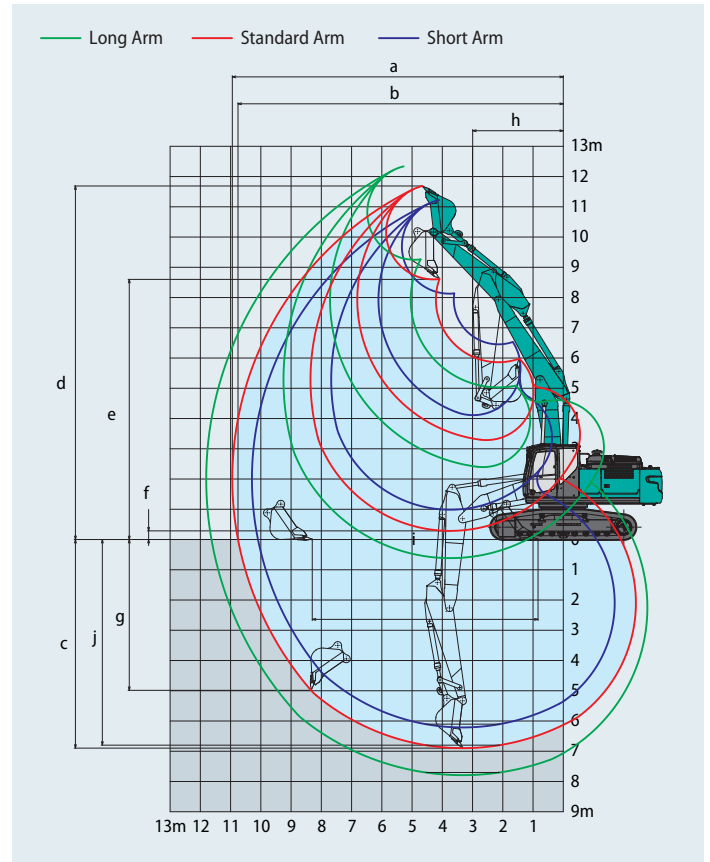

Digging Force (ISO 6015)

Unit: kN

Arm length	Short 2.40 m	Standard 3.10 m	Long 4.00 m
Bucket digging force	188 208*	188 208*	188 208*
Arm crowding force	158 174*	126 139*	105 115*

*Power Boost engaged.



Dimensions

Arm length	Short 2.40 m	Standard 3.10 m	Long 4.00 m
A Overall length	10,840	10,780	10,860
B Overall height (to top of boom)	3,280	3,110	3,470
C Overall width of crawler	SK300LC	3,190	
	SK300NLC	2,990	
D Overall height (to top of cab)	3,200		
E Ground clearance of rear end*	1,200		
F Ground clearance*	490		

Unit: mm

G Tail swing radius	3,300	
G' Distance from centre of swing to rear end	3,270	
H Tumbler distance	4,000	
I Overall length of crawler	4,870	
J Track gauge	SK300LC	2,590
	SK300NLC	2,390
K Shoe width	600	
L Overall width of upperstructure	2,980	

*Without including height of shoe lug

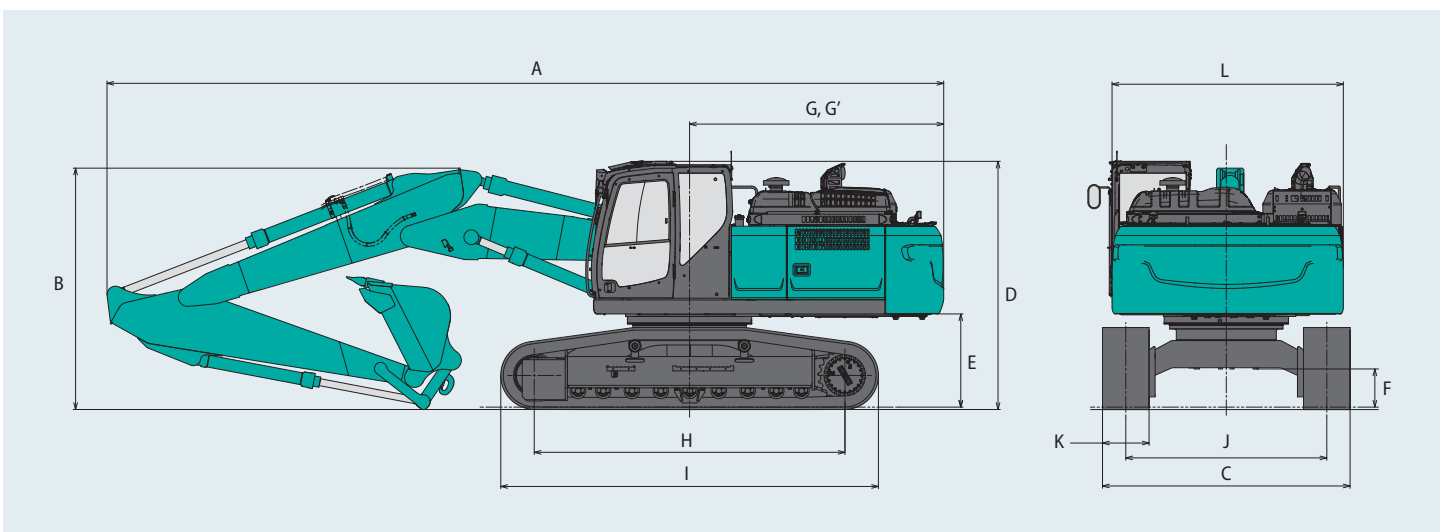

Operating weight & ground pressure



In standard trim, with 2 Piece Boom, 3.10 m arm, and 1.20 m³ ISO heaped bucket, counterweight 4,940 kg

Shaped			Triple grouser shoes (even height)				Double grouser shoes
Shoe width	mm		600	700	800	900	600
Overall width of crawler	SK300LC	mm	3,190	3,290	3,390	3,490	3,190
	SK300NLC	mm	2,990	3,090	—	—	2,990
Ground pressure	SK300LC	kPa	60	52	46	42	60
	SK300NLC	kPa	60	52	—	—	60
Operating weight	SK300LC	kg	31,500	32,100	32,500	32,900	31,600
	SK300NLC	kg	31,400	32,100	—	—	31,600

In standard trim, with 2 Piece Boom, 3.10 m arm, and 1.20 m³ ISO heaped bucket, counterweight 5,540 kg

Shaped			Triple grouser shoes (even height)				Double grouser shoes
Shoe width	mm		600	700	800	900	600
Overall width of crawler	SK300LC	mm	3,190	3,290	3,390	3,490	3,190
	SK300NLC	mm	2,990	3,090	—	—	2,990
Ground pressure	SK300LC	kPa	60	53	47	42	61
	SK300NLC	kPa	61	53	—	—	61
Operating weight	SK300LC	kg	32,100	32,700	33,100	33,500	32,200
	SK300NLC	kg	32,000	32,700	—	—	32,200

Lift capacities

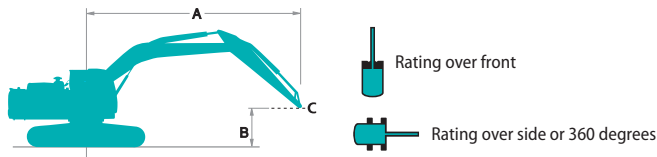

A - Reach from swing centerline to arm top
 B - Arm top height above/below ground
 C - Lift point
 Relief valve setting: 37.8 MPa {385 kgf/cm²}

SK300LC		2 Piece Boom		Arm: 3.10 m		Bucket: without		Counterweight: 4,940 kg		Shoe: 600 mm (Heavy Lift)		At max. reach		Radius			
B	A	1.5 m		3.0 m		4.5 m		6.0 m		7.5 m		9.0 m					
	9.0 m	kg								*5,750	*5,750				*4,940	*4,940	6.12 m
7.5 m	kg								*8,240	*8,240	*4,650	*4,650			*4,340	*4,340	7.55 m
6.0 m	kg								*8,630	8,200	*4,850	*4,850			*4,030	*4,030	8.46 m
4.5 m	kg				*18,030	*18,030	*12,020	*12,020	*9,510	7,750	*4,520	*4,520	*3,950	*3,950	*3,810	*3,810	9.03 m
3.0 m	kg				*21,760	21,560	*14,380	10,940	*10,570	7,210	*4,520	*4,520	*4,560	3,880	*3,750	3,640	9.32 m
1.5 m	kg				*25,200	19,650	*15,810	10,020	*11,390	6,730	*5,020	4,920	*4,810	3,760	*3,830	3,540	9.36 m
G.L.	kg				*22,270	19,300	*15,770	9,640	11,090	6,420	*6,070	4,730	*4,690	3,690	*4,060	3,610	9.14 m
-1.5 m	kg				*10,830	*10,830	*14,630	9,590	*8,780	6,310	*7,330	4,660			*4,510	3,880	8.66 m
-3.0 m	kg				*15,690	*15,690	*12,510	9,750	*9,700	6,380	*7,180	4,750			*5,360	4,500	7.86 m
-4.5 m	kg	*26,470	*26,470	*22,130	20,800	*13,680	10,300		*8,150	6,710					*5,280	*5,280	6.61 m

SK300LC		2 Piece Boom		Arm: 2.40 m		Bucket: without		Counterweight: 4,940 kg		Shoe: 600 mm (Heavy Lift)		At max. reach		Radius	
B	A	1.5 m		3.0 m		4.5 m		6.0 m		7.5 m		At max. reach			
	9.0 m	kg						*10,680	*10,680					*7,070	*7,070
7.5 m	kg								*6,310	*6,310			*5,450	*5,450	6.72 m
6.0 m	kg						*11,240	*11,240	*9,390	7,990	*5,410	*5,410	*4,780	*4,780	7.73 m
4.5 m	kg				*14,850	*14,850	*13,250	11,690	*10,190	7,560	*5,510	5,340	*4,480	4,440	8.36 m
3.0 m	kg				*20,090	*20,090	*14,970	10,670	*11,110	7,050	*5,610	5,110	*4,400	4,080	8.67 m
1.5 m	kg				*25,060	20,410	*16,030	9,970	11,330	6,640	*6,180	4,900	*4,500	3,960	8.71 m
G.L.	kg	*27,700	*27,700	*24,270	19,810	*14,930	9,660	*7,560	6,430	*7,140	4,770	*4,800	4,070	8.48 m	
-1.5 m	kg						*13,570	9,740	*10,670	6,400	*7,590	4,770	*5,410	4,460	7.95 m
-3.0 m	kg						*10,960	9,980	*8,670	6,560			*6,500	5,350	7.07 m
-4.5 m	kg				*17,560	*17,560							*4,490	*4,490	5.64 m

Lift capacities

SK300LC		2 Piece Boom		Arm: 4.00 m		Bucket: without		Counterweight: 4,940 kg		Shoe: 600 mm (Heavy Lift)		At max. reach		Radius		
B	A	1.5 m		3.0 m		4.5 m		6.0 m		7.5 m		9.0 m				
10.5 m	kg													*4,210	*4,210	5.52 m
9.0 m	kg													*3,420	*3,420	7.39 m
7.5 m	kg									*4,240	*4,240			*3,070	*3,070	8.60 m
6.0 m	kg							*6,800	*6,800	*6,690	5,750	*3,840	*3,840	*2,910	*2,910	9.41 m
4.5 m	kg					*8,420	*8,420	*8,360	7,960	*7,330	5,500	*3,860	*3,860	*2,860	*2,860	9.92 m
3.0 m	kg	*36,410	*36,410	*19,720	*19,720	*12,650	11,420	*9,570	7,340	*7,920	5,180	*3,900	3,830	*2,900	*2,900	10.19 m
1.5 m	kg	*17,480	*17,480	*24,050	19,380	*14,710	10,180	*10,630	6,730	8,090	4,850	*4,170	3,650	*3,020	2,950	10.22 m
G.L.	kg	*18,570	*18,570	*6,600	*6,600	*15,520	9,460	10,970	6,290	*4,380	*4,380	*4,630	3,510	*3,200	2,990	10.03 m
-1.5 m	kg			*9,930	*9,930	*15,130	9,200	10,710	6,050	*5,830	4,430	*4,970	3,440	*3,510	3,170	9.59 m
-3.0 m	kg			*14,380	*14,380	*13,690	9,220	*9,640	6,020	*7,260	4,420			*4,060	3,570	8.87 m
-4.5 m	kg					*11,070	9,480	*8,430	6,170	*5,950	4,590			*5,090	4,400	7.80 m
-6.0 m	kg			*17,650	*17,650	*10,470	10,150							*3,720	*3,720	6.17 m

SK300LC		2 Piece Boom		Arm: 3.10 m		Bucket: without		Counterweight: 5,540 kg		Shoe: 600 mm (Heavy Lift)		At max. reach		Radius		
B	A	1.5 m		3.0 m		4.5 m		6.0 m		7.5 m		9.0 m				
9.0 m	kg							*5,750	*5,750					*4,940	*4,940	6.12 m
7.5 m	kg							*8,240	*8,240	*4,650	*4,650			*4,340	*4,340	7.55 m
6.0 m	kg							*8,630	*8,630	*4,850	*4,850			*4,030	*4,030	8.46 m
4.5 m	kg			*18,030	*18,030	*12,020	*12,020	*9,510	8,190	*4,520	*4,520	*3,950	*3,950	*3,810	*3,810	9.03 m
3.0 m	kg			*21,760	*21,760	*14,380	11,580	*10,570	7,640	*4,520	*4,520	*4,560	4,140	*3,750	*3,750	9.32 m
1.5 m	kg			*25,200	20,900	*15,810	10,660	*11,390	7,160	*5,020	*5,020	*4,810	4,020	*3,830	3,790	9.36 m
G.L.	kg			*22,270	20,550	*15,770	10,280	*11,620	6,860	*6,070	5,060	*4,690	3,950	*4,060	3,860	9.14 m
-1.5 m	kg			*10,830	*10,830	*14,630	10,230	*8,780	6,750	*7,330	4,990			*4,510	4,160	8.66 m
-3.0 m	kg			*15,690	*15,690	*12,510	10,390	*9,700	6,810	*7,180	5,080			*5,360	4,810	7.86 m
-4.5 m	kg	*26,470	*26,470	*22,130	22,050	*13,680	10,940	*8,150	7,140					*5,280	*5,280	6.61 m

SK300LC		2 Piece Boom		Arm: 2.40 m		Bucket: without		Counterweight: 5,540 kg		Shoe: 600 mm (Heavy Lift)		At max. reach		Radius		
B	A	1.5 m		3.0 m		4.5 m		6.0 m		7.5 m		9.0 m				
9.0 m	kg							*10,680	*10,680					*7,070	*7,070	5.05 m
7.5 m	kg									*6,310	*6,310			*5,450	*5,450	6.72 m
6.0 m	kg							*11,240	*11,240	*9,390	8,420	*5,410	*5,410	*4,780	*4,780	7.73 m
4.5 m	kg			*14,850	*14,850	*13,250	12,330	*10,190	7,990	*5,510	*5,510	*4,480	*4,480	*4,480	*4,480	8.36 m
3.0 m	kg			*20,090	*20,090	*14,970	11,320	*11,110	7,480	*5,610	5,430	*4,400	4,350	*4,400	4,350	8.67 m
1.5 m	kg			*25,060	21,660	*16,030	10,610	*11,670	7,070	*6,180	5,220	*4,500	4,240	*4,500	4,240	8.71 m
G.L.	kg	*27,700	*27,700	*24,270	21,070	*14,930	10,300	*7,560	6,860	*7,140	5,090	*4,800	4,350	*4,800	4,350	8.48 m
-1.5 m	kg					*13,570	10,380	*10,670	6,830	*7,590	5,100	*5,410	4,760	*5,410	4,760	7.95 m
-3.0 m	kg					*10,960	10,620	*8,670	6,990			*6,500	5,700	*6,500	5,700	7.07 m
-4.5 m	kg			*17,560	*17,560							*4,490	*4,490	*4,490	*4,490	5.64 m

SK300LC		2 Piece Boom		Arm: 4.00 m		Bucket: without		Counterweight: 5,540 kg		Shoe: 600 mm (Heavy Lift)		At max. reach		Radius		
B	A	1.5 m		3.0 m		4.5 m		6.0 m		7.5 m		9.0 m				
10.5 m	kg													*4,210	*4,210	5.52 m
9.0 m	kg													*3,420	*3,420	7.39 m
7.5 m	kg									*4,240	*4,240			*3,070	*3,070	8.60 m
6.0 m	kg							*6,800	*6,800	*6,690	6,080	*3,840	*3,840	*2,910	*2,910	9.41 m
4.5 m	kg					*8,420	*8,420	*8,360	*8,360	*7,330	5,830	*3,860	*3,860	*2,860	*2,860	9.92 m
3.0 m	kg	*36,410	*36,410	*19,720	*19,720	*12,650	12,070	*9,570	7,770	*7,920	5,500	*3,900	*3,900	*2,900	*2,900	10.19 m
1.5 m	kg	*17,480	*17,480	*24,050	20,630	*14,710	10,820	*10,630	7,160	*8,480	5,170	*4,170	3,910	*3,020	*3,020	10.22 m
G.L.	kg	*18,570	*18,570	*6,600	*6,600	*15,520	10,110	*11,230	6,720	*4,380	*4,380	*4,630	3,770	*3,200	*3,200	10.03 m
-1.5 m	kg			*9,930	*9,930	*15,130	9,840	*11,170	6,490	*5,830	4,760	*4,970	3,700	*3,510	3,410	9.59 m
-3.0 m	kg			*14,380	*14,380	*13,690	9,870	*9,640	6,450	*7,260	4,740			*4,060	3,840	8.87 m
-4.5 m	kg					*11,070	10,120	*8,430	6,600	*5,950	4,920			*5,090	4,710	7.80 m
-6.0 m	kg			*17,650	*17,650	*10,470	*10,470							*3,720	*3,720	6.17 m

SK300NLC		2 Piece Boom Arm: 3.10 m Bucket: without Counterweight: 4,940 kg Shoe: 600 mm (Heavy Lift)														
B	A	1.5 m		3.0 m		4.5 m		6.0 m		7.5 m		9.0 m		At max. reach		Radius
9.0 m	kg							*5,750	*5,750					*4,940	*4,940	6.12 m
7.5 m	kg							*8,240	7,750	*4,650	*4,650			*4,340	*4,340	7.55 m
6.0 m	kg							*8,630	7,530	*4,850	*4,850			*4,030	*4,030	8.46 m
4.5 m	kg			*18,030	*18,030	*12,020	11,090	*9,510	7,100	*4,520	*4,520	*3,950	3,260	*3,810	3,590	9.03 m
3.0 m	kg			*21,760	18,940	*14,380	9,880	*10,570	6,560	*4,520	*4,520	*4,560	3,520	*3,750	3,310	9.32 m
1.5 m	kg			*25,200	17,140	*15,810	8,980	11,360	6,090	*5,020	4,460	*4,810	3,410	*3,830	3,210	9.36 m
G.L.	kg			*22,270	16,820	*15,770	8,620	11,010	5,790	*6,070	4,280	*4,690	3,340	*4,060	3,260	9.14 m
-1.5 m	kg			*10,830	*10,830	*14,630	8,570	*8,780	5,690	*7,330	4,210			*4,510	3,520	8.66 m
-3.0 m	kg			*15,690	*15,690	*12,510	8,720	*9,700	5,750	*7,180	4,300			*5,360	4,080	7.86 m
-4.5 m	kg	*26,470	*26,470	*22,130	18,230	*13,680	9,260	*8,150	6,070					*5,280	*5,280	6.61 m

SK300NLC		2 Piece Boom Arm: 2.40 m Bucket: without Counterweight: 4,940 kg Shoe: 600 mm (Heavy Lift)														
B	A	1.5 m		3.0 m		4.5 m		6.0 m		7.5 m		At max. reach		Radius		
9.0 m	kg							*10,680	*10,680					*7,070	*7,070	5.05 m
7.5 m	kg									*6,310	*6,310			*5,450	*5,450	6.72 m
6.0 m	kg							*11,240	*11,240	*9,390	7,330	*5,410	5,020	*4,780	4,720	7.73 m
4.5 m	kg			*14,850	*14,850	*13,250	10,600	*10,190	6,900	*5,510	4,880	*4,480	4,050	*4,480	4,050	8.36 m
3.0 m	kg			*20,090	19,690	*14,970	9,620	*11,110	6,400	*5,610	4,650	*4,400	3,710	*4,400	3,710	8.67 m
1.5 m	kg			*25,060	17,860	*16,030	8,940	11,250	6,000	*6,180	4,440	*4,500	3,600	*4,500	3,600	8.71 m
G.L.	kg	*27,700	*27,700	*24,270	17,310	*14,930	8,640	*7,560	5,800	*7,140	4,320	*4,800	3,690	*4,800	3,690	8.48 m
-1.5 m	kg							*13,570	8,710	*10,670	5,770	*7,590	4,320	*5,410	4,040	7.95 m
-3.0 m	kg							*10,960	8,950	*8,670	5,930			*6,500	4,450	7.07 m
-4.5 m	kg			*17,560	*17,560									*4,490	*4,490	5.64 m













SK300NLC		2 Piece Boom Arm: 4.00 m Bucket: without Counterweight: 4,940 kg Shoe: 600 mm (Heavy Lift)														
B	A	1.5 m		3.0 m		4.5 m		6.0 m		7.5 m		9.0 m		At max. reach		Radius
10.5 m	kg													*4,210	*4,210	5.52 m
9.0 m	kg													*3,420	*3,420	7.39 m
7.5 m	kg									*4,240	*4,240			*3,070	*3,070	8.60 m
6.0 m	kg							*6,800	*6,800	*6,690	5,280	*3,840	3,730	*2,910	*2,910	9.41 m
4.5 m	kg					*8,420	*8,420	*8,360	7,290	*7,330	5,030	*3,860	3,630	*2,860	*2,860	9.92 m
3.0 m	kg	*36,410	*36,410	*19,720	*19,720	*12,650	10,330	*9,570	6,680	*7,920	4,710	*3,900	3,470	*2,900	2,750	10.19 m
1.5 m	kg	*17,480	*17,480	*24,050	16,880	*14,710	9,130	*10,630	6,090	*8,040	4,390	*4,170	3,300	*3,020	2,660	10.22 m
G.L.	kg	*18,570	*18,570	*6,600	*6,600	*15,520	8,440	10,900	5,650	*4,380	4,130	*4,630	3,160	*3,200	2,680	10.03 m
-1.5 m	kg			*9,930	*9,930	*15,130	8,180	10,630	5,430	*5,830	3,980	*4,970	3,090	*3,510	2,850	9.59 m
-3.0 m	kg			*14,380	*14,380	*13,690	8,200	*9,640	5,390	*7,260	3,970			*4,060	3,210	8.87 m
-4.5 m	kg					*11,070	8,450	*8,430	5,540	*5,950	4,140			*5,090	3,970	7.80 m
-6.0 m	kg			*17,650	*17,650	*10,470	9,100							*3,720	*3,720	6.17 m















SK300NLC		2 Piece Boom Arm: 3.10 m Bucket: without Counterweight: 5,540 kg Shoe: 600 mm (Heavy Lift)														
B	A	1.5 m		3.0 m		4.5 m		6.0 m		7.5 m		9.0 m		At max. reach		Radius
9.0 m	kg							*5,750	*5,750					*4,940	*4,940	6.12 m
7.5 m	kg							*8,240	8,160	*4,650	*4,650			*4,340	*4,340	7.55 m
6.0 m	kg							*8,630	7,940	*4,850	*4,850			*4,030	*4,030	8.46 m
4.5 m	kg			*18,030	*18,030	*12,020	11,700	*9,510	7,510	*4,520	*4,520	*3,950	3,870	*3,810	*3,810	9.03 m
3.0 m	kg			*21,760	20,090	*14,380	10,480	*10,570	6,970	*4,520	*4,520	*4,560	3,770	*3,750	3,550	9.32 m
1.5 m	kg			*25,200	18,290	*15,810	9,590	*11,390	6,500	*5,020	4,770	*4,810	3,660	*3,830	3,450	9.36 m
G.L.	kg			*22,270	17,970	*15,770	9,220	11,560	6,210	*6,070	4,590	*4,690	3,590	*4,060	3,510	9.14 m
-1.5 m	kg			*10,830	*10,830	*14,630	9,170	*8,780	6,100	*7,330	4,530			*4,510	3,780	8.66 m
-3.0 m	kg			*15,690	*15,690	*12,510	9,320	*9,700	6,160	*7,180	4,610			*5,360	4,380	7.86 m
-4.5 m	kg	*26,470	*26,470	*22,130	19,380	*13,680	9,860	*8,150	6,490					*5,280	*5,280	6.61 m

Notes:

- Do not attempt to lift or hold any load that is greater than these lift capacities at their specified lift point radius and heights. Weight of all accessories must be deducted from the above lift capacities.
- Lift capacities are based on machine standing on level, firm, and uniform ground. User must make allowance for job conditions such as soft or uneven ground, out of level conditions, side loads, sudden stopping of loads, hazardous conditions, experience of personnel, etc.
- Arm top defined as lift point.
- The above lift capacities are in compliance with ISO 10567. They do not exceed 87% of hydraulic lift capacity or 75% of tipping load. Lift capacities marked with an asterisk (*) are limited by hydraulic capacity rather than tipping load.
- Operator should be fully acquainted with the Operator's and Maintenance Instructions before operating this machine. Rules for safe operation of equipment should be adhered to at all times.
- Lift capacities apply to only machine as originally manufactured and normally equipped by KOBELCO CONSTRUCTION MACHINERY CO., LTD.

Lift capacities

SK300NLC		2 Piece Boom		Arm: 2.40 m		Bucket: without		Counterweight: 5,540 kg		Shoe: 600 mm (Heavy Lift)				
B	A	1.5 m		3.0 m		4.5 m		6.0 m		7.5 m		At max. reach		Radius
														
9.0 m	kg					*10,680	*10,680					*7,070	*7,070	5.05 m
7.5 m	kg							*6,310	*6,310			*5,450	*5,450	6.72 m
6.0 m	kg					*11,240	*11,240	*9,390	7,740	*5,410	5,330	*4,780	*4,780	7.73 m
4.5 m	kg			*14,850	*14,850	*13,250	11,210	*10,190	7,320	*5,510	5,190	*4,480	4,320	8.36 m
3.0 m	kg			*20,090	*20,090	*14,970	10,230	*11,110	6,820	*5,610	4,970	*4,400	3,970	8.67 m
1.5 m	kg			*25,060	19,010	*16,030	9,550	*11,670	6,420	*6,180	4,760	*4,500	3,860	8.71 m
G.L.	kg	*27,700	*27,700	*24,270	18,450	*14,930	9,250	*7,560	6,210	*7,140	4,630	*4,800	3,960	8.48 m
-1.5 m	kg					*13,570	9,320	*10,670	6,180	*7,590	4,630	*5,410	4,330	7.95 m
-3.0 m	kg					*10,960	9,550	*8,670	6,340			*6,500	5,190	7.07 m
-4.5 m	kg			*17,560	*17,560							*4,490	*4,490	5.64 m

SK300NLC		2 Piece Boom		Arm: 4.00 m		Bucket: without		Counterweight: 5,540 kg		Shoe: 600 mm (Heavy Lift)						
B	A	1.5 m		3.0 m		4.5 m		6.0 m		7.5 m		9.0 m		At max. reach		Radius
																
10.5 m	kg													*4,210	*4,210	5.52 m
9.0 m	kg													*3,420	*3,420	7.39 m
7.5 m	kg									*4,240	*4,240			*3,070	*3,070	8.60 m
6.0 m	kg							*6,800	*6,800	*6,690	5,590	*3,840	*3,840	*2,910	*2,910	9.41 m
4.5 m	kg					*8,420	*8,420	*8,360	7,710	*7,330	5,350	*3,860	*3,860	*2,860	*2,860	9.92 m
3.0 m	kg	*36,410	*36,410	*19,720	*19,720	*12,650	10,940	*9,570	7,090	*7,920	5,020	*3,900	3,720	*2,900	*2,900	10.19 m
1.5 m	kg	*17,480	*17,480	*24,050	18,030	*14,710	9,740	*10,630	6,500	8,440	4,700	*4,170	3,550	*3,020	2,870	10.22 m
G.L.	kg	*18,570	*18,570	*6,600	*6,600	*15,520	9,040	*11,230	6,070	*4,380	*4,380	*4,630	3,410	*3,200	2,910	10.03 m
-1.5 m	kg			*9,930	*9,930	*15,130	8,790	*11,170	5,840	*5,830	4,290	*4,970	3,340	*3,510	3,080	9.59 m
-3.0 m	kg			*14,380	*14,380	*13,690	8,810	*9,640	5,800	*7,260	4,280			*4,060	3,470	8.87 m
-4.5 m	kg					*11,070	9,060	*8,430	5,950	*5,950	4,450			*5,090	4,270	7.80 m
-6.0 m	kg			*17,650	*17,650	*10,470	9,710							*3,720	*3,720	6.17 m

Notes:

- Do not attempt to lift or hold any load that is greater than these lift capacities at their specified lift point radius and heights. Weight of all accessories must be deducted from the above lift capacities.
- Lift capacities are based on machine standing on level, firm, and uniform ground. User must make allowance for job conditions such as soft or uneven ground, out of level conditions, side loads, sudden stopping of loads, hazardous conditions, experience of personnel, etc.
- Arm top defined as lift point.
- The above lift capacities are in compliance with ISO 10567. They do not exceed 87% of hydraulic lift capacity or 75% of tipping load. Lift capacities marked with an asterisk (*) are limited by hydraulic capacity rather than tipping load.
- Operator should be fully acquainted with the Operator's and Maintenance Instructions before operating this machine. Rules for safe operation of equipment should be adhered to at all times.
- Lift capacities apply to only machine as originally manufactured and normally equipped by KOBELCO CONSTRUCTION MACHINERY CO., LTD.

Standard and Optional Equipment



● = Std ○ = Opt — = N/A

Category	Description	SK300LC/SK300NLC-11E	
		Mono Boom / 2 Piece Boom	
		LC	NLC
Engine	ISUZU 6HK1 (EU Stage V compliant)	●	●
	Exhaust DOC DPF SCR system	●	●
	Alternator 24 V /90 A	●	●
	Starter motor 24 V/5 kW	●	●
	Batteries 2 x 12 V (140 Ah)	●	●
	Fan suction type cooling system	●	●
	Auto deceleration function	●	●
	Auto idle stop (AIS)	●	●
Hydraulic system	3 work modes H, S, Eco	●	●
	Power boost (37.8 MPa {385 kgf/cm ² })	●	●
	Heavy lift mode	●	●
	Pressure release function	●	●
	Independent travel function	●	●
	Auto warm up system	●	●
	Proportional Hand Control (for E&N&B piping)	●	●
	Hydraulic oil VG32	●	●
	Hydraulic oil VG46	○	○
	Hydraulic oil VG68	○	○
Piping	E & N&B piping	●	●
	E & N&B piping + Bigger capacity P4 pump (84.9 L/min)	○	○
	Standard piping (only mono boom spec)	○	—
	QH piping	●	●
Cabin	Air suspension seat with heating	●	●
	10 inch colour monitor	●	●
	LED door light	●	●
	Air-conditioner	●	●
	DAB+ radio (FM/AM & AUX & USB & Bluetooth* & hands free telephone)	●	●
	Harness for CAB four lights and CAB yellow flasher	●	●
	Parallel wiper	●	●
	12V power outlet	●	●
	Rain visor	○	○
	Sun screen	○	○
Lights	LED work lights ; 2 on Boom, 1 on upper frame, 2 on rear counterweight	●	●
	LED work lights ; 2 on Cab top front	○	○
Working equipment	Standard Boom (6.20 m)	●	●
	2 Piece Boom	○	○
	Standard HD arm (3.10 m) with rock guard	●	●
	Short HD arm (2.40 m) with rock ruard	○	○
	Long HD arm (4.00 m) with rock guard	○	○
Counterweight	OHK hook	●	●
	Standard C/W (TTL 4,935 kg)	●	●
Undercarriage	Semi heavier C/W (TTL 5,535 kg)	○	○
	600 mm steel shoe	●	●
	600 mm double grouser shoe	○	○
	700 mm steel shoe	○	○
	800 mm steel shoe	○	—
	900 mm steel shoe	○	—
	Track guide (one per side)	●	●
	Additional track guides (two additional per side)	○	○
Safety	Lower frame guard	●	●
	Engine emergency stop switch	●	●
	Pump emergency mode (KPSS release switch)	●	●
	Emergency accel dial	●	●
	Emergency manual valve for lowering attachment	●	●
	Overload alarm	●	●
	Safety valve for boom & arm cylinder	●	●
	ROPS compliant cab (ISO 12117-2:2008)	●	●
	OPG Level II top guard (ISO 10262;1998)	●	●
	OPG Level II front guard (ISO 10262;1998)	○	○
	Eagle-eye view camera (Rear, Right, Left)	●	●
	Seatbelt indicator on display	●	●
	Travel alarm	○	○
	Extended handrail	○	○
	Others	Refueling pump	●
Harness for engine room light		●	●
RAL color		○	○
KOMEXS		●	●

*The air conditioning system on this machine contains fluorinated greenhouse gas HFC-134a (GWP 1430). Quantity of gas 0.9 kg (CO² equivalent 1.3 t).
 Note: Bluetooth* is a registered trademark of the Bluetooth SIG Inc.

Note: This catalogue may contain attachments and optional equipment that are not available in your area. And it may contain photographs of machines with specifications that differ from those of machines sold in your areas. Please consult your nearest KOBELCO distributor for those items you require.
Specialist equipment is needed to use this machine in demolition work. Before using it please contact your KOBELCO dealer.
Due to our policy of continuous product improvements all designs and specifications are subject to change without advance notice.
Copyright by **KOBELCO CONSTRUCTION MACHINERY CO., LTD.** catalogue may be reproduced in any manner without notice.

KOBELCO CONSTRUCTION MACHINERY EUROPE B.V.

Veluwezoom 15
1327 AE Almere
The Netherlands
www.kobelco-europe.com

Enquiries To: