

KOBELCO

TKE750G

Telescopic Boom Crawler Crane

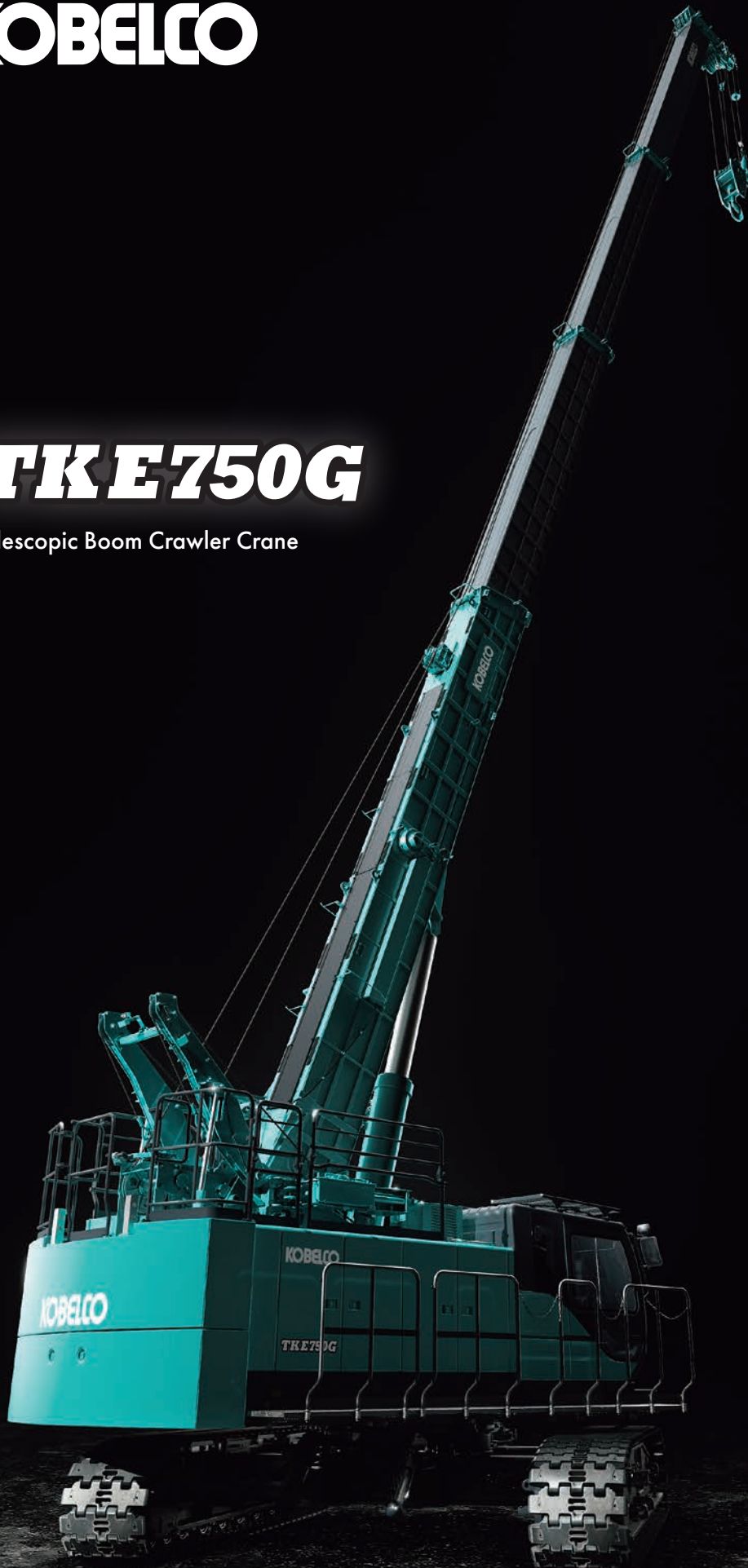

Max. Lifting Capacity

75 t
× **3.0 m**

Boom length : 10.0m - 30.1m

TELESCOPIC BOOM CRAWLER CRANE

TOUGH



TITAN

THE ORIGIN

TOUGH TELE

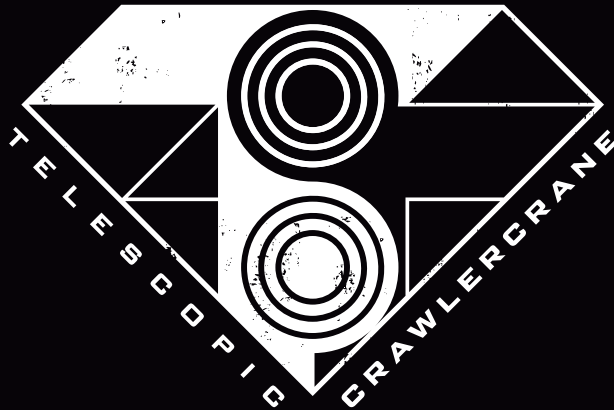

TOUGH
×
TELESCOPIC

TOUGH TELE is the unique technology of the compact and tough TK series with its winch layout and robust structure.



Boom, Boom Hoist Cylinder and Swing Frame on The Same Axis

The TK boom is designed to withstand uneven side-to-side forces even during hard foundation work as the box boom hoist cylinder supports the center of the boom and the center of the swing frame is on the same axis as the center of the boom.

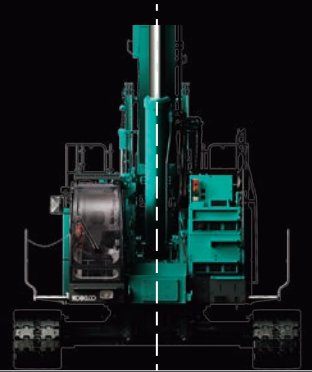

PURPOSE

Side Deflection-Resistant Fully Powered Boom for All Lifting

Tough 4-plate box boom structure with special welding quality standards, but lightweight



The 4-plate box boom with stiffeners



The TK's tough and lightweight boom is achieved with the reinforced welding of stiffeners and distortion adjustment of the boom by skilled craftsmen, as well as optimizing the materials and structure.

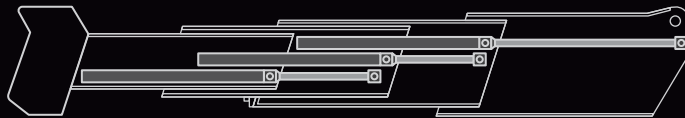

Each section of the telescopic boom has its own built-in telescopic cylinder for smooth and powerful boom extension and retraction.

A Superstructure Designed to Take on Tough Jobs

The upper frame is designed to be durable for winch operation with high line pull. In addition, the fixed swing bearing bolts are optimally placed, and penetrate the swing frame, resulting in a structure with exceptional and efficient dispersion of lift forces.

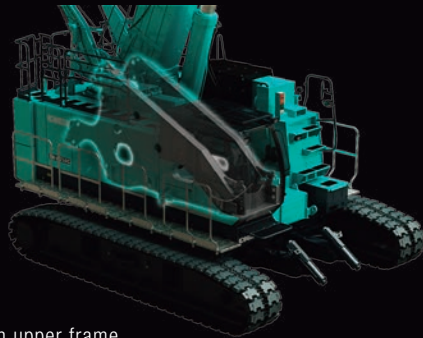

Tough upper frame

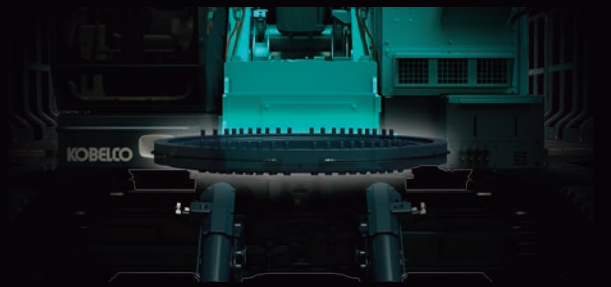

Swing bearing and frame unique bolt penetrating structure

BUILT DURABLE DESIGN FOR FOUNDATION WORKS

COMPACT AND EFFICIENT FOR STABLE PERFORMANCE

Combining Compact and High Crane Performance

The vertical layout of the main & aux. winches helps achieve a compact design and efficient weight balance. Optional front mounted third drum (non-free fall) achieves a low center of gravity, and ease of wiring from the ground means no working at height. The boom foot is located at the rear of the main body and boom's own weight has enough force to hold the rear of the upper frame down, contributing to the machine's stability.

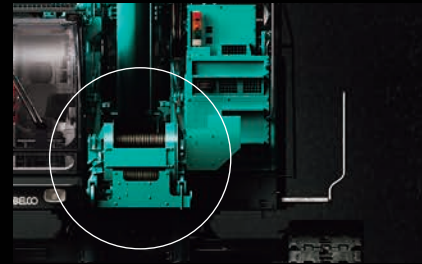
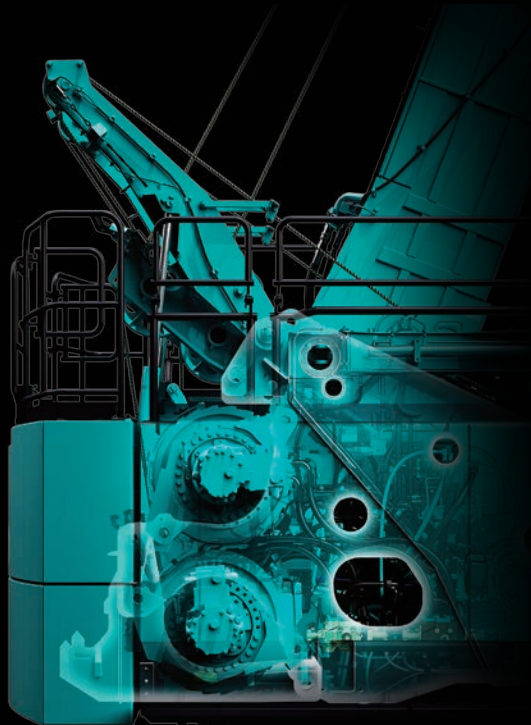

Optional front mounted 3rd drum



Boom foot at the rear of main body

Vertical Lay-Out of Main & Aux. Winches

Powerful Winch and Engine Spec

Winch (Main/Aux.)

Max. Line Speed (1st drum layer)	: 110m/min
Rated Line Pull (Single line)	: 68.6kN {7.0ft}
Winch Max. Line Pull (Referential performance)*	: 153.1kN {15.6ft}
Wire Rope Diameter	: 22mm
Wire Rope Length	: 170m (Main) 75m (Aux.)

*Winch Max. Line Pull is not based on wire rope strength.

DESIGN CE

Compact Body for Urban Civil Engineering and Foundation Work

The 4.1m tail swing radius improves workability in confined spaces. In addition, the width of the machine is 3.2m when the crawlers are retracted, allowing the machine to enter narrow job-sites.*

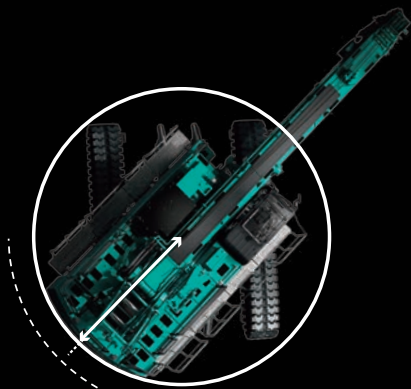

Tail swing radius
4.1m



Overall width of crawlers (retracted)
3.2m

*Crawlers should be fully extended before and during work operations.
No work can be performed while the crawlers are retracted.

Engine Output

254kW (345PS) / 2,000min⁻¹

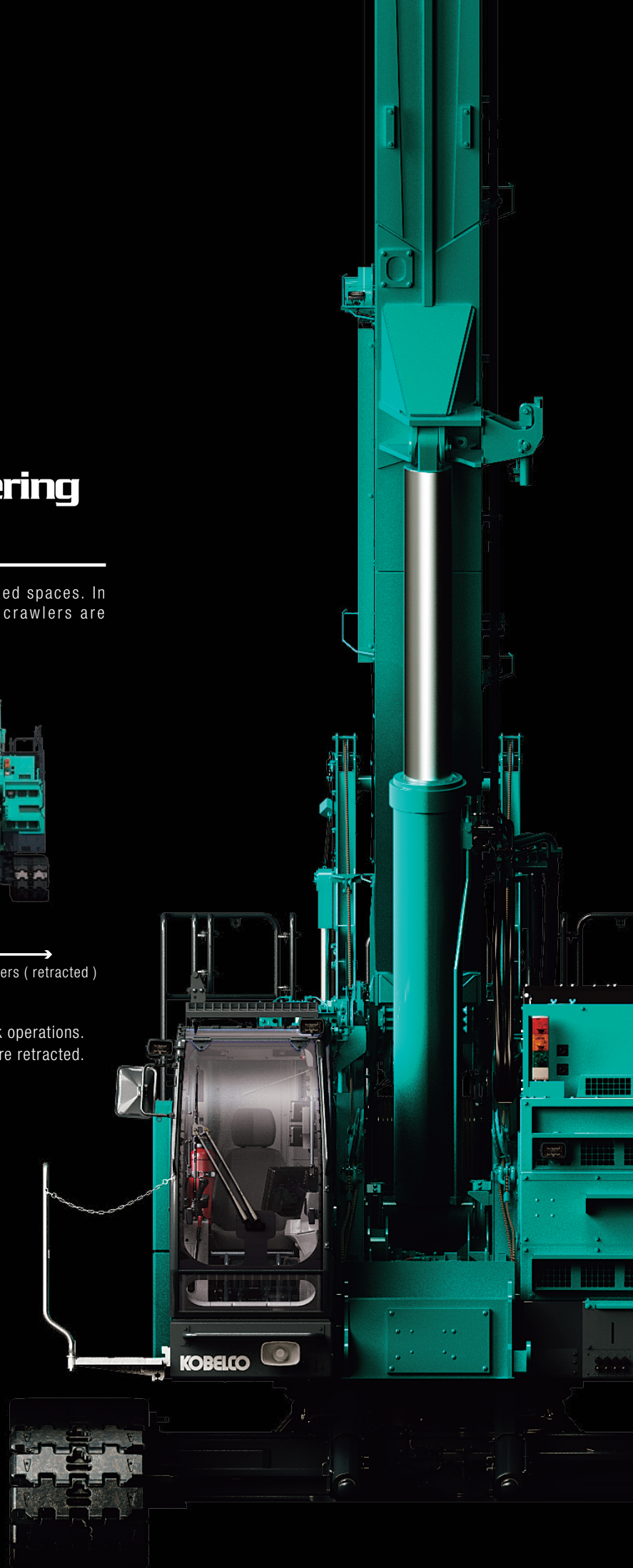

Reliable Equipment for Foundation Work

Strong Winch

Innovative Wet-Type Disc Brake System

A wet-type disc brake winch ensures continuous braking capacity and a large braking force, which can be applied with a light pedal operation. Furthermore, the disc is cooled by a forced hydraulic oil cooling system from a large hydraulic tank specifically designed for high-duty cycle work, especially during continuous free fall operation. This ensures that the precise and full braking force is applied. Periodical adjustment, maintenance, or changing the braking discs is greatly reduced, helping keep running costs low. Sealing the braking discs ensures no braking noise or unpleasant squeaking occurs.

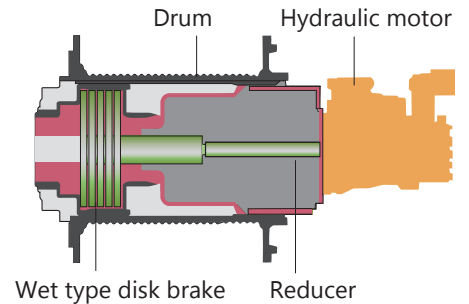

Wide and Large Capacity Drum

Both the main and auxiliary drums are wide and grooved, with a large capacity that can spool in 23 rows of 22mm-diameter wire rope. The maximum rope capacity (working length) of the main drum is 170m, making it suitable for a variety of tasks. The large spooling capacity in one layer also has the advantage of preventing damage to the wire rope.

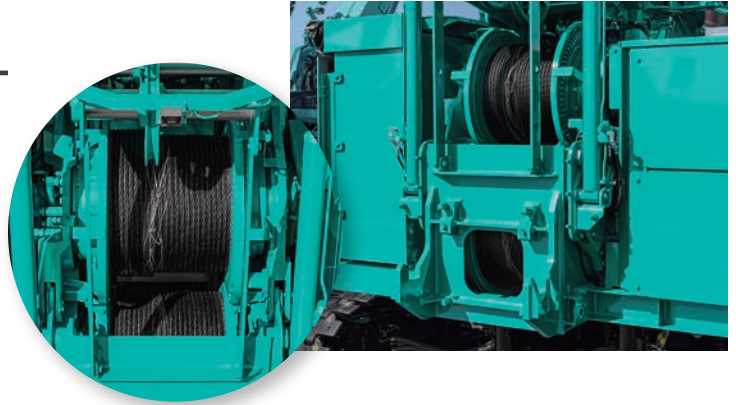

Third Winch (Without Free-Fall) [optional]

A third winch without free fall with an 18mm diameter wire rope is available as an option, and is suitable for a variety of foundation attachments and work methods.

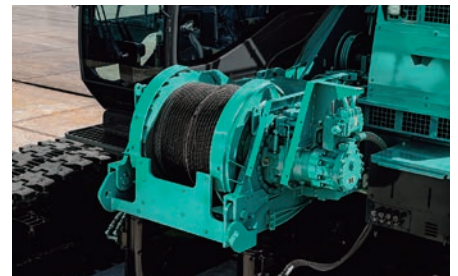

High Engine Output

Features a high-performance engine of 254kW/345PS, which is comparable to a KOBELCO 200t crawler crane. In addition, a hydraulic outlet is available for a hydraulic auger.

254kW (345PS) / 2,000min⁻¹

Equipped with exhaust gas after-treatment device (DPF+SCR)

*Hydraulic outlet is optional.

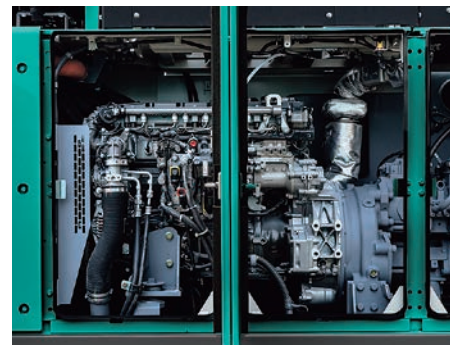

Basic Crane Capacity

Supported by High Stability

Max. Rated Load
75t×3.0m

Rated Line Pull [Single line]
68.6kN {7.0tf}

Main Hook Max. Hoist Height
30.4m

Max. Line Speed
110m/min [1st layer]

**Strong lifting capacity
in the heavy lifting range**

① **43.2t×5.0m**

**Lifting capacity
in front of the machine** ② to ⑤

Minimum working radius **3.0m**
for all boom lengths (10.0m to 30.1m),
allows free layout of the site.

**High lifting capacity
for practical tasks**

Focused on lifting capacity at a working
radius of 10m, which is effective for
vibration hammers, auger drilling
operations etc.

⑥ [30.1m boom]
13.5t×10.0m

⑦ [23.4m boom]
16.3t×10.0m

**High lifting capacity
for height restricted sites**

⑧ Height limit 7m
26.4t×7.5m

⑨ Height limit 9m
30.6t×6.7m

Lifting capacity for various tasks

Max. boom length when horizontal

⑩ **2.7t×27.8m**

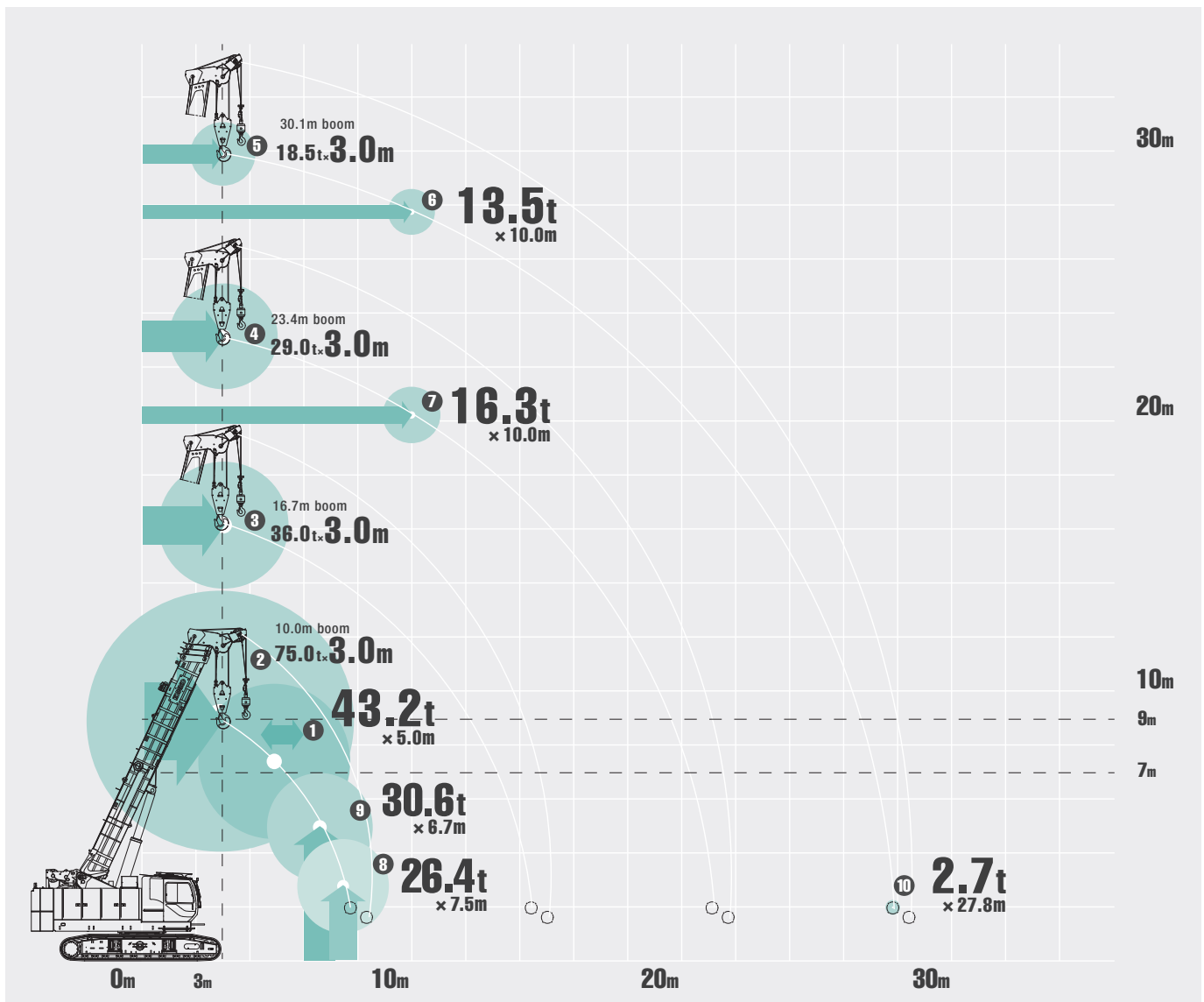

Ease of Transportation & Assembly

Enables Quick Start on Site

Ease of Transportation

The machine can be transported with its crawlers, ready for use on site in a short time.

(Unit: mm)

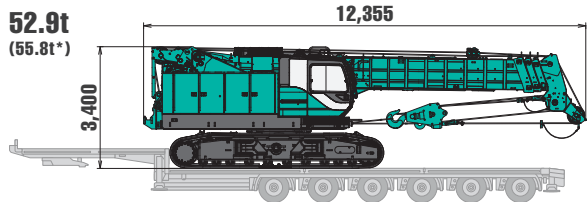
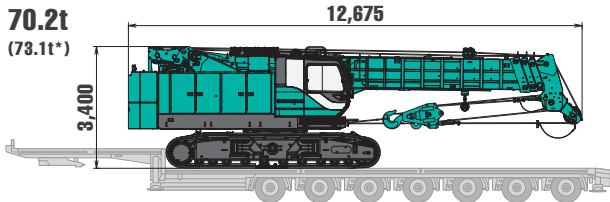

Without counterweights

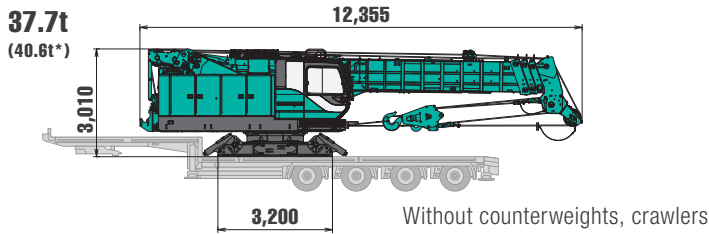

Without counterweights, crawlers

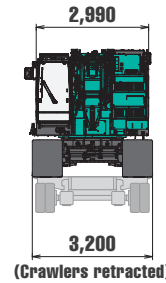

Overall width of crawlers (retracted)

*With third winch and other optional parts / attachments

Ease of Assembly

Self-Assembly

Assembly is almost unnecessary. The counterweight self-removal device (optional) and the crawler self-removal device make it possible to install them without assistant crane.



Crawlers can be self-mounted and removed using a special suspension balance, with a working radius of up to 5.5m.



The counterweight can be assembled by operating the winch and raising and lowering the counterweight self-removal arm.

Daily Maintenance Made Easy and Simple

The robust guard design allows easy and safe maintenance and is the same as KOBELCO's Lattice Boom Crawler Cranes. The guards can be opened separately at the point needing maintenance, and the catwalks are wide, giving safe and easy access.

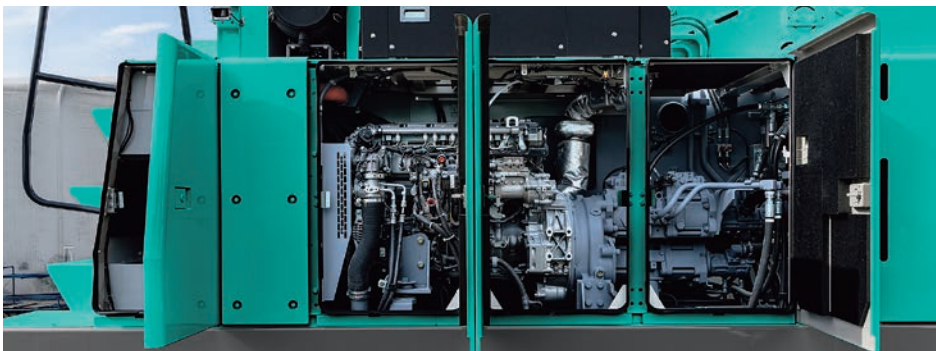

Comfortable and Spacious Operator Cabin

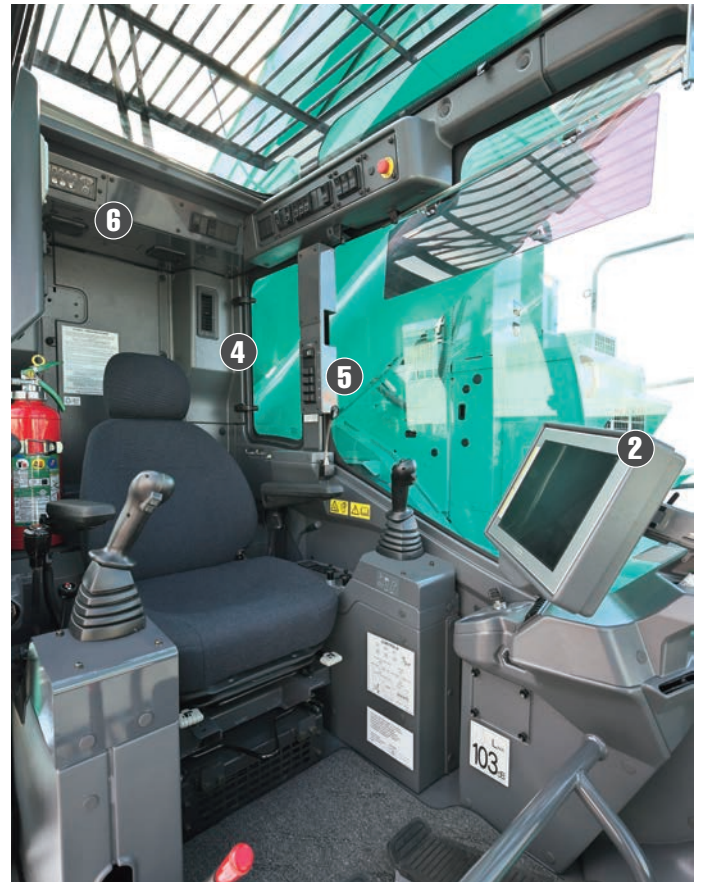

1 Comfortable Operating Environment

A spacious cabin (3.10m³) and a wide view (1.09m²) provide a comfortable working environment for enhanced safety and workability.

2 ML Monitor

The monitor can be adjusted to any preferred angle, making it easy to see. The monitor's clear image quality ensures it can be checked even at extreme angles, improving safety in operations.

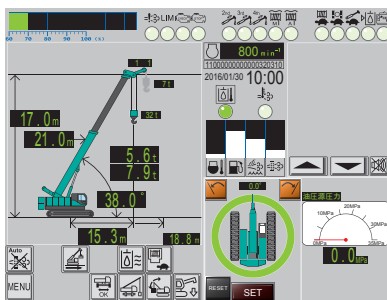

3 Wide Cabin Entrance

The wide access area of the cabin (785mm) reduces the stress of getting in and out, and enhances operator comfort.

4 Air Conditioner Vent

An air conditioner vent located under the ML monitor provides cabin comfort. 4 vents are also placed at the back of the cabin.

5 Switch for Foundation Applications [optional]

Switches for controlling augers, hydraulic outlets, etc. are concentrated in one place on the left side for ease of operation.

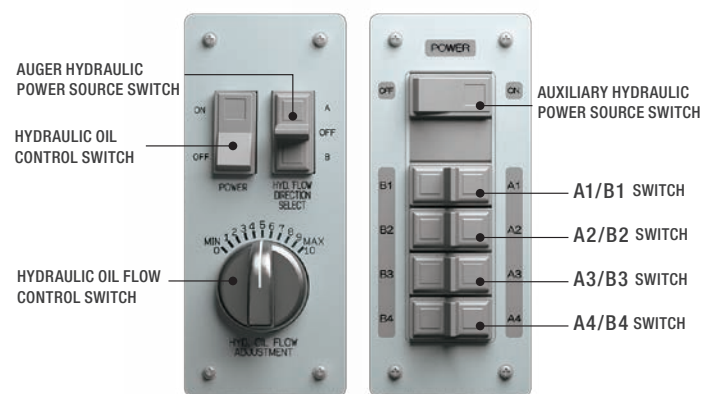

6 Bluetooth® and a Hands-Free Phone Mounting

Features include a radio with Bluetooth® capability and a built-in hands-free phone.



FOUNDATION APPLI

Auger Casing

A leader is attached to the crane on which an auger and a casing are mounted. Peripheral soil is excavated and the pile is extracted using the base machine itself or by an auxiliary crane.



Hammer-Grabs for All Casing Methods

The All Casing attachment is used for cast-in-place piling. Underground obstacles such as small boulders, or a hard layer of rock, are cut or chipped away by a hammer grab bucket. Soil, rocks, and sand are removed from inside the casing tube with the hammer grab. After casting the concrete, the casing tube is pulled out. A hammer grab is also used to remove existing piles.



CATIONS WITH **TK**



Vibration Hammers

There are two types of vibratory hammers: electrically or hydraulically operated. Piles are driven or extracted by vertical vibration of the hammer.

Auger Drilling Pre-Bored Piles



Drilling methods with auger screws, that is drilling down with auger screws for inserting piles. The advantage of the auger drilling with a telescopic crane is smoother operation at sites where height differs between the machine and drilling ground. The TK can provide hydraulic power for the drilling auger, enabling greater freedom when job planning and working on-site.





KOBELCO has developed a remote operation management system for its cranes. Machines fitted with this system transmit working conditions, location, and maintenance history providing owners with fact-based, operational information that gives a tremendous advantage for their asset management.

Main Functions



LOCATION

> Acquire Working Condition and Location of the Fleet

The system is based on satellite mapped images, Internet connection, and other means to remotely monitor a crane's working condition and its location. This information is useful in planning maintenance schedules and providing guidance to operators, helping to ensure that crane owners can maximize their fleet efficiency.



WORKING

> Managing Safety/Operational Records and Monitoring Working Status

Crane owners can monitor and record the working condition and operational status of onsite machines on entire fleet basis, promoting greater crane safety.



SAFETY

> Remote Failure Diagnosis

It is possible to narrow down possible failure causes quicker and more accurately by remotely accessing to the current and historical status of the machine, helping to minimize the machine downtime.



MAINTENANCE

> Preventive Maintenance Ensures Good Machine Condition and Protects Value

The system recommends appropriate parts replacement timing based on the machine working hour. Regular maintenance can help the machines running at peak performance at all times.

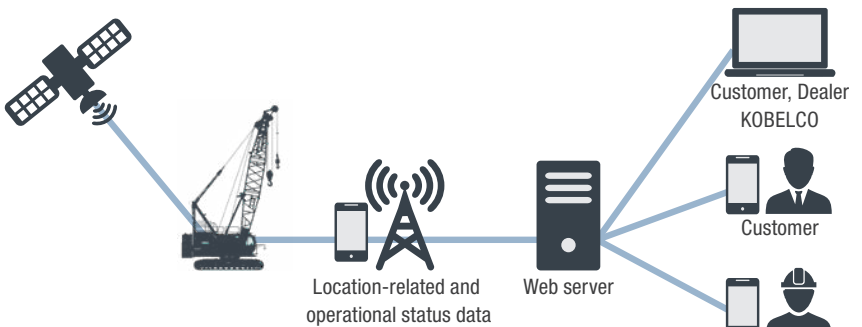

Viewing of machine data via the Internet allows provision of complex machine data

Using the Internet, customers can check on a crane's operational status from the office, and its location can be checked with GPS. Operation data such as whether or not a crane is in operation, total operating and idling hours, etc., is displayed in easy-to-read graph and table formats.



Location display



KCROSS reports
(Possible to customize data)

Detailed Machine and Operation Data Can Be Accessed over the Internet

Operating data for a given crane can be accessed and accurately monitored from the Internet terminal in the crane owner's office.

Main Data Handled

- Map: Shows past and latest locations and travel history of all machines in the owner's fleet.
- Performance record: Hours of operation, Lift operations, and Safety record in the period of a day, a week, or other desired time-span.
- At-a-glance function: Outputs a report (in the form of a record log or sheet) that shows whether or not the machine is currently operating, its total operating hours, and other operating data.



Operation data can be received on a mobile phone

When necessary, this system can send data as a text message to a mobile phone



Note

- Compatible crane models
KOBELCO hydraulic crawler cranes (G series or later), including some conventional models.
- User registration and Internet access environment are required.

Main Specifications

Main Specifications

Crane Performance		
Max. Rated Load	10.0m boom	75.0t x 3.0m (11-lines)
	16.7m boom	36.0t x 4.5m (6-lines)
	23.4m boom	29.0t x 6.0m (5-lines)
	30.1m boom	18.5t x 8.0m (4-lines)
	Aux. Sheave (Max.)	7.0t (1-line)
Main Boom Length	10.0m to 30.1m	
Main Hook Max. Hoist Height	30.4m	
Main Hook Max. Operating Radius	27.8m	
Winch (Main / Aux.)		
Max. Line Speed (1st layer)	110m/min	
Rated Line Pull (Single line)	68.6kN (7.0tf)	
Max. Line Pull (Referential performance)*2	153.1kN (15.6tf)	
Wire Rope Diameter	22mm	
Wire Rope Length	170m (Main), 75m (Aux.)	
Brake Type (Free fall)	Wet-type multiple disc brake	
Winch (Third [without free fall]*1)		
Max. Line Speed (1st layer)	87m/min	
Rated Line Pull (Single line)	52.0kN (5.3tf)	
Max. Line Pull (Referential performance)*2	107.0kN (10.9tf)	
Wire Rope Diameter	18mm	
Wire Rope Length	170m	
Working Speed		
Swing Speed	2.5min ⁻¹ {rpm}	
Travel Speed	1.6 / 1.1 km/h (high / low select)	
Boom Telescoping Speed	125 / 20.1sec/m	
Boom Raising Speed	64sec / 0 to 83 degrees	

Power Plant	
Model	Mercedes-Benz E9H01 (Daimler OM936LA) Complies with NRMM (Europe) Stage V
Engine Output	254kW / 2,000min ⁻¹
Fuel Tank	400L
AdBlue [®] Tank Usable Volume	40L
Hydraulic System	
Main Pumps	4 pumps (2 variable plunger pumps + 2 gear pumps) + 4 pumps (2 variable plunger pumps + 2 gear pumps)
Max. Pressure	31.9MPa {325kgf/cm ² }
Oil Quantity (at the reference level)	791L
Self-Removal Device (Optional)	
	Counterweight
Weight	
Operating Weight	70.2t
Ground Pressure	83.8kPa {0.86kgf/cm ² }
Counterweight	17,200kg
Transport Weight	52,900kg*3 (55,800kg*4)

Units are SI units. { } indicates conventional units.
Line speeds in table are for light loads. Line speed varies with load.

*1 Third winch is optional

*2 Max. line pull is not based on wire rope strength.

*3 Base machine with hook, without counterweight

*4 With third winch and other optional parts / attachments

General Dimensions

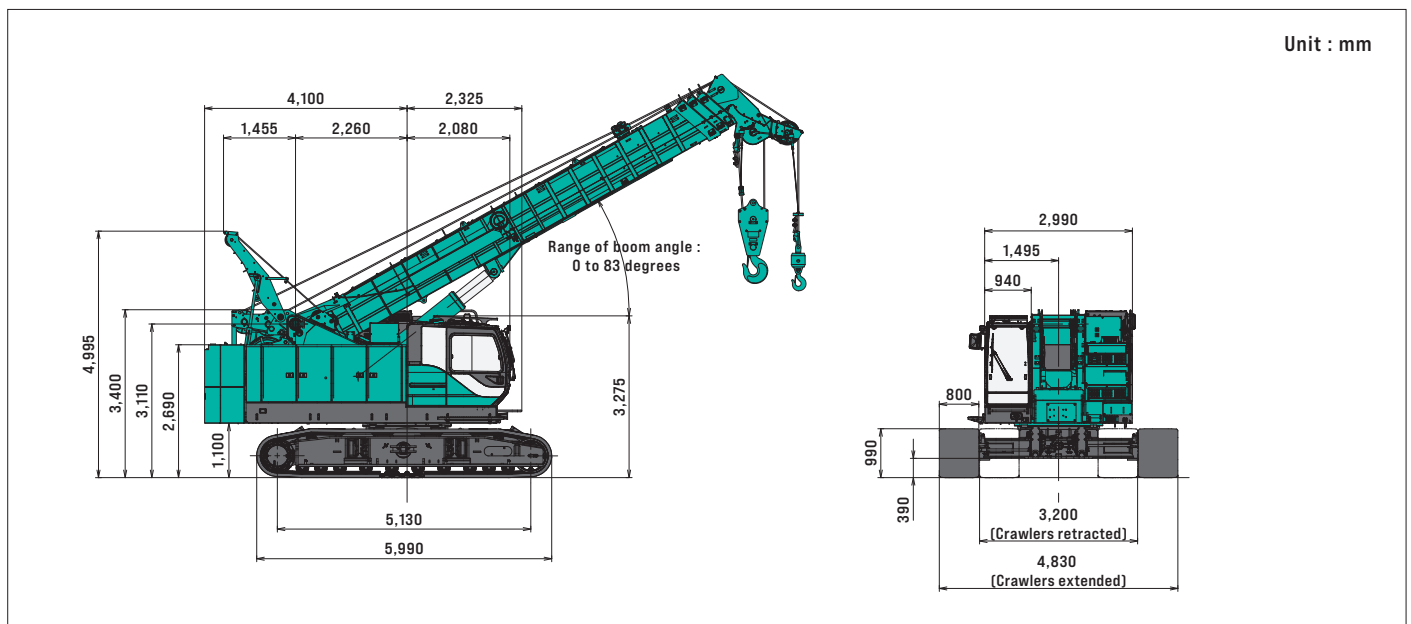

TKE750G specifications catalog



KOBELCO CONSTRUCTION MACHINERY EUROPE B.V.

Veluwezoom 15, 1327 AE Almere, The Netherlands

TEL: +31 36 2020 300

www.kobelco-europe.com

Note: This catalog may contain photographs of machines with specifications, attachments and optional equipment that are not available in your area. Please consult KOBELCO for those items you may require. Due to our policy of continuous product improvements all designs and specifications are subject to change without prior notice.

Copyright by KOBELCO CONSTRUCTION MACHINERY CO., LTD. No part of this catalog may be reproduced in any manner without prior permission.



KOBELCO CONSTRUCTION MACHINERY CO., LTD.

5-15, Kitashinagawa 5-chome, Shinagawa-ku, Tokyo 141-8626 JAPAN

TEL: +81 3 5789 2121

www.kobelco-global.com

Inquiries to :